



Skill India
कौशल भारत - कुशल भारत



सत्यमेव जयते
GOVERNMENT OF INDIA
MINISTRY OF SKILL DEVELOPMENT
& ENTREPRENEURSHIP



N S D C
National
Skill Development
Corporation

Transforming the skill landscape

Facilitator Guide

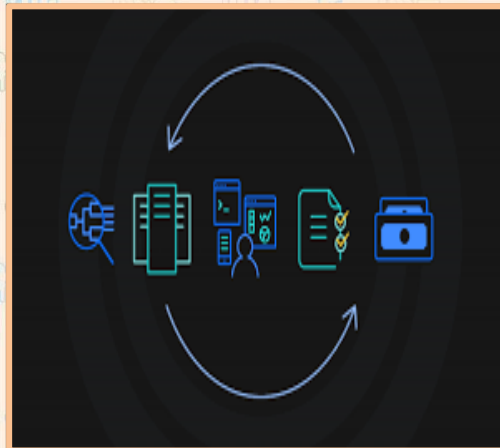
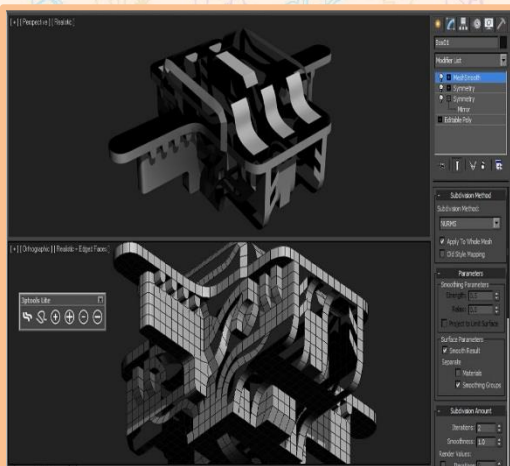

Sector
Media and Entertainment

Sub-Sector
Animation, Gaming

Occupation
Asset Creation

Modeller

Reference ID: **MES/Q2501, Version 1.0**
NSQF Level: **4**

Published by:

All Rights Reserved,
First Edition, March 2016

Printed in India at

Copyright © 2016

Media and Entertainment Sector Skill Council

Contact Details:

Address: Media & Entertainment Skills Council, 522-524, 5th Floor, DLF Tower A Jasola New Delhi-110025

E-mail: info@mescindia.com

Website: www.mescindia.org

Disclaimer

The information contained herein has been obtained from sources reliable to Media and Entertainment. Media and Entertainment disclaims all warranties to the accuracy, completeness or adequacy of such information. Media and Entertainment shall have no liability for errors, omissions, or inadequacies, in the information contained herein, or for interpretations thereof. Every effort has been made to trace the owners of the copyright material included in the book. The publishers would be grateful for any omissions brought to their notice for acknowledgements in future editions of the book. No entity in Media and Entertainment shall be responsible for any loss whatsoever, sustained by any person who relies on this material. The material in this publication is copyrighted. No parts of this publication may be reproduced, stored or distributed in any form or by any means either on paper or electronic media, unless authorized by the Media and Entertainment.





Shri Narendra Modi
Prime Minister of India

“ Skilling is building a better India.
If we have to move India towards
development then Skill Development
should be our mission. ”

Acknowledgement

Media & Entertainment Skills Council (MESC) would like to express its gratitude to all the individuals and institutions who contributed in different ways towards the preparation of this “Facilitator Guide”. Without their contribution it could not have been completed. Special thanks are extended to those who collaborated in the preparation of its different modules. Sincere appreciation is also extended to all who provided peer review for these modules.

The preparation of this manual would not have been possible without the Media and Entertainment Industry’s support. Industry feedback has been extremely encouraging from inception to conclusion and it is with their input that we have tried to bridge the skill gaps existing today in the Industry.

This manual is dedicated to the aspiring youth who desire to achieve special skills which will be a lifelong assets for future endeavors

About this Guide

This Participant Handbook is designed to enable training for the specific Qualification Pack (QP).

Each National Occupational (NOS) is covered across Unit/s.

Key Learning Objectives for the specific NOS mark the beginning of the Unit/s for that NOS.

- Introduction & Orientation
- Interpret the script/brief/storyboard
- Prepare computer generated models
- Test computer generated models
- Maintain Workspace Healthy and Safety

Symbols Used



Steps



Time



Tips



Notes



Objectives



Do



Ask



Explain



Elaborate



Field Visit



Practical



Lab



Demonstrate



Exercise



Team Activity



Facilitation Notes



Learning Outcomes



Say



Resources



Activity



Summary



Role Play



Example

Table of Contents

S. No.	Modules and Units	Page No.
1 .	Introduction & Orientation	1
	Unit 1.1 - Introduction to the Media and Entertainment	3
	Unit 1.2 –Duties and responsibilities of Modeller	5
2 .	Interpret the script/brief/storyboard (MES/N2501)	9
	Unit 2.1 – Fundamental and Principles of Animation and Modeling	11
	Unit 2.2 – Life Drawings: Human Anatomy Fundamentals	17
	Unit2.3 - Animation Production Process	22
	Unit2.4 - Create Hookup Poses and Animation	27
3 .	Prepare computer generated models (MES/N2502)	32
	Unit 3.1 – Create Prototypes/Pilots for Testing	34
	Unit 3.2- Produce 3D Animation, Pipeline and Modeling	36
	Unit 3.3- Creating, Manipulating and Viewing Objects	42
	Unit 3.4- Viewing the Maya 3D Scene	45
	Unit 3.5- Polygonal Modelling	49
	Unit 3.6- NURBS Modeling	52
	Unit 3.7- Animation	56
4 .	Test computer generated models (MES/N2503)	60
	Unit 4.1- Testing the models and quality assurance	62
5 .	Maintain Workspace Healthy and Safety (MES/N0104)	66
	Unit 5.1 – Maintain Workspace healthy and safety	68
6 .	Soft Skills and Communication Skills	71
	Unit 6.1 - Introduction to the Soft Skills	73
	Unit 6.2 - Effective Communication	76
	Unit 6.3 - Grooming and Hygiene	79
	Unit 6.4 - Interpersonal Skill Development	85
	Unit 6.5 - Social Interaction	93
	Unit 6.6 - Group Interaction	97
	Unit 6.7 - Time Management	100
	Unit 6.8 - Resume Preparation	103
	Unit 6.9 - Interview Preparation	107
7 .	IT Skills	111
	Unit 7.1 - Introduction to Computer	113
	Unit 7.2 - Basic Computer Knowledge	115
	Unit 7.3 - Components of Computer	117
	Unit 7.4 - Concept of Operating System	119
	Unit 7.5- Ms word	122
	Unit 7.6 - MS PowerPoint	124
	Unit 7.7 - MS Excel	126
	Unit 7.8 - Internet Concepts	128



Skill India
कौशल भारत - कुशल भारत



सत्यमेव जयते
GOVERNMENT OF INDIA
MINISTRY OF SKILL DEVELOPMENT
& ENTREPRENEURSHIP



N.S.D.C.
National
Skill Development
Corporation

Transforming the skill landscape



1. Introduction and Orientation

Unit 1.1 - Introduction to the Media and Entertainment

Unit 1.2 –Duties and Responsibilities of Modeller

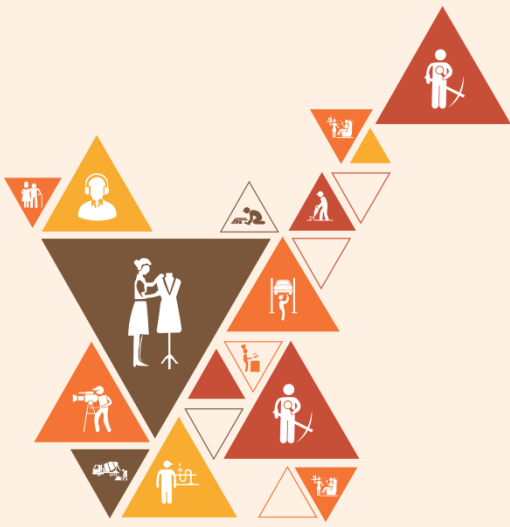

Key Learning Outcomes



At the end of the module, you will be able to:

- Describe the role and responsibilities of a modeller with respect to the media and entertainment industry
- Discuss the application of models to be created by modeller
- Discuss the process involved in creation of model – storyboard, modelling, texturing, rigging and animation

Unit 1.1: Introduction to Media and Entertainment

Objective

At the end of this unit, you will be able to:

- Explain about the Media & Entertainment Industry
- Interpret importance of Media & Entertainment in everyday life.
- Describe the role and responsibility of Modeller.

Resources to be used

- Available objects such as black or white Board, chalk pieces or white board marker pens, duster.
- PC with LCD Projector or Flip Chart.
- Participant Manual
- Copies of Handouts.

Do

- Welcome the participants to the program
- Introduce yourself to the participants mentioning about you, your name and work experience.
- Before starting the session tell them what they are going to learn in this program.

Say

Discuss the topic going to learn about Modeller.

Elaborate

The Indian media and entertainment (M&E) sector are one of the biggest in the world. It is placed as 14th largest in the world. This sector is 1.7% of Indian GDP and expected to be 2.2% of GDP with INR 4.5 lakh crores in 2022. The sector employs 9.3% of the workforce of our country and we are expecting it to be 17% till the end of 2017.

From 2014 to 2018 Media and Entertainment sector has grown by approximately 11 percent CAGR which makes Media and Entertainment sector INR 1.43 trillion industry. It is estimated that Indian Media and Entertainment market will flourish to CAGR of 13.1% in FY 18-23 reaching at INR 2.66 trillion.

Say

The Indian M&E industry comprises several sub-sectors, such as television, radio, print media (including newspapers and magazines), films, animation and visual effects (VFX), Sound & Music, Amusement & Theme Parks, Art & Culture, and Event Management/Live Performances.

- Advertising industry is the major revenues generating part of the industry and the growth of the sector decides the overall growth of the industry.
- Although there is not much to export from this industry, but imports have a considerable share in the economy like imports of newsprints, set-top boxes and antennae

Elaborate



India is one of the largest broadcasters in the world with approximately 800 TV channels, 242 FM channels and more than 100 community radio networks working at present. Bollywood, the Indian film industry is the largest producer of films around the globe with 400 production and corporate houses involved.

- The Government of India keeps on pushing the Media and Entertainment industry by launching various schemes such as digitizing the cable TV to fill greater institutional funding, raising the foreign investment from 74 per cent to 100 per cent in cable and DTH satellite platforms. Government has also allotted industry status to the film industry for easy finance.
- Another high growth sub-sector is Gaming which grew by 35.1% in FY 2018 as compared to FY 2017. The projected growth of industry for FY 2018 to 2023 is given in next figure.

Say



Now tell the participants about employability in media and entertainment sector.

Elaborate



The Media & Entertainment sector employs 11-12 lakh people directly (as per 2017 reports) and if we consider indirect employments as well then count goes to 35-40 lakh people. The Media sector is highly dependent on advertising revenues and performance of Industry for economy outlook. This sector was having 4 lakhs workforce in 2013 and we expect it to reach 13 lakhs by 2022 which means employing 9 lakhs of additional employment in the period of 2013-22.

Say



Tell participants about major subsector and segments.

- The Indian M&E industry comprises several sub-sectors, such as television, radio, print media (including newspapers and magazines), films, animation and visual effects (VFX), Sound & Music, Amusement & Theme Parks, Art & Culture, and Event Management/Live Performances.
- Advertising industry is the major revenues generating part of the industry and the growth of the sector decides the overall growth of the industry.
- Although there is not much to export from this industry, but imports have a considerable share in the economy like imports of newsprints, set-top boxes and antennae.

Notes for Facilitation



- Ask participants about their expectations from this program.
- Tell participants to complete the questions at the end of the sub unit.
- Ask participants if they have any doubts. Encourage them to ask questions.
- Answer their queries satisfactorily.

Unit 1.2 Duty and responsibilities of Modeller

Objective

At the end of this unit, you will be able to:

- Analyze the role and responsibilities of Modeller.
- Explain with technical terms associated with animation and modelling

Resources to be used

- Available objects such as black or white Board, chalk pieces or white board marker pens, duster.
- Job Card/Job description
- Pc with LCD Projector or Flip Chart.
- Participant Manual
- Copies of Handouts.

Do

- Greet and welcome the participants to the next session of the program.
- Before starting the session ask them to do, they have any doubts pertaining to the previous unit.
- Acknowledge their responses and clear their doubts if any.
- Tell them they will learn about technical terms associated with role of Modeller, also explain roles and responsibilities of Modeller.

Say

Role of Modeller

Key Responsibilities

To design, draw, create and re model virtually assisted sketches, tools, characters and symbols by working closely with Supervisor.

Skill Set Requirements

Duties may be characterized by attention to detail and vivid imagination that helps design innovative human anatomy related structures and characters with the help of software's like 3D Studio Max, Maya etc. The requires artistic creativity to enable perfect capture of human expressions, emotions and body language apart from basic structure of body.

Role Description

- * Ability to build 3D animated models using given reference and ensuring accuracy of design
- * Research on design to support or enhance given CGI project
- * Working under the Production or Art Designers by being technically vigilant to their requirement, being reliable by creating easy to rig or animate models
- * Understanding the outcome or further requirement to team to enable providing Texture Artists and Riggers to easily work on the models by enhancing them with accurate light and depth.
- * Conceptual understanding of instructions given by Department heads via storyboards or layouts to smoothen the outcome process
- * Flexibility to work all roles on smaller projects and to work in a team with bigger projects that require detail attention to rigging, textures and lighting.

Say



Major Subsector and Segments

- Advertising plays a crucial role in sustaining the performance of media and entertainment industry, as the revenue collected with advertising mediums supports and grows the overall economy.
- The industry does not rely so much on foreign materials and produces most equipment, appliances and systems in house. A minor portion of exports may include antennas, cables and satellite boxes.

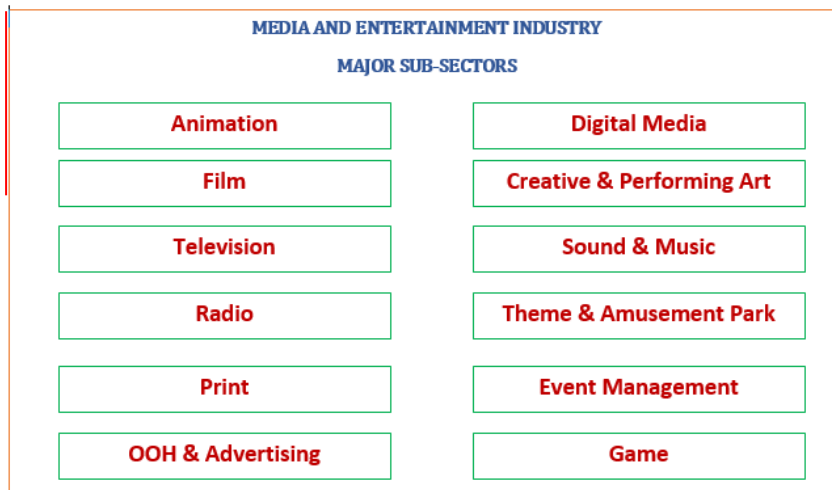

Fig.1.2.1: Media and Entertainment Sector

Notes for Facilitation



- Summarize the main points.
- Tell participants to complete the questions at the end of the subunit.
- Ask participants if they have any doubts. Encourage them to ask questions.
- Answer their queries satisfactorily.



Skill India
कौशल भारत - कुशल भारत



सत्यमेव जयते
GOVERNMENT OF INDIA
MINISTRY OF SKILL DEVELOPMENT
& ENTREPRENEURSHIP



N S · D · C
National
Skill Development
Corporation

Transforming the skill landscape



Media & Entertainment Skills Council

2. Interpret the Script/Brief/Storyboard

Unit 2.1 Fundamental and Principles of Animation and Modeling

Unit 2.2 Life Drawings: Human Anatomy Fundamentals (Story Script)

Unit 2.3 Animation Production Process

Unit 2.4 Create Hookup Poses and Animation

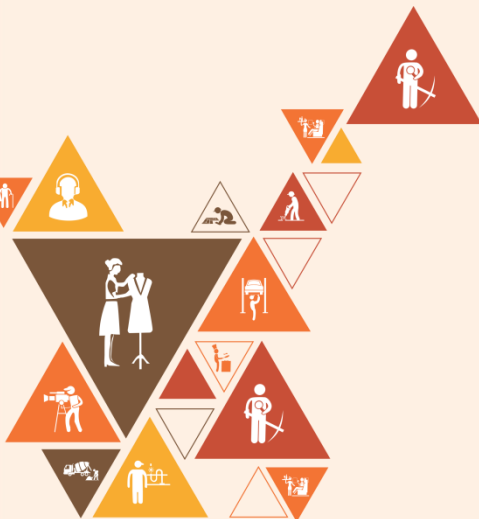

MES/N2501

Key Learning Outcomes



At the end of the module, you will be able to:

- Discuss basic principles of style and color theory like layout, composition etc.
- Describe the ways that of analyzing a script/storyboard.
- Distinguish between the elements of model to be.
- Discuss the challenges which can be sweet-faced throughout production.
- Determine necessary tools for coming up with the model.
- Interpret the sequences for making model as per story line.
- Prepare the technical want sheet relevant to project that model must be ready.
- Discuss the challenges which can be sweet-faced throughout production.

Unit 2.1 Fundamentals and Principles of Animation and Modelling

Objectives

At the end of this unit, students will be able to:

- Analyze key rules and techniques to animation.
- Interpret script / story brief
- Explain creation of model.

Resources to be used

- Available objects such as black or white Board, chalk pieces or white board marker pens, duster.
- Pc with LCD Projector or Flip Chart.
- Participant Manual
- Copies of Handouts.

Do

- Welcome the participants to the program
- Introduce yourself to the participants mentioning about you, your name and work experience.
- Before starting the session tell them what they are going to learn in this program.

Say

Tell them that they are going to learn about:

- Principles of animation.
- Modelling Process
- Basics of 3D Modelling

Elaborate

The movement of images by using several frames to correspond the live movement of design through time and vision. A basic movement like a tree swaying to a complex one of a tree growing from a plant can all fall under Animation design

Animation has defined its own principles over the years. Although most of these principles emerged from the traditional 2D world of animation, most definitions, terminologies, and principles of movement can be applied to all of animation's disciplines. Many of these principles will be covered in detail and more specifically in the sections on 2D and 3D animation, but here is an overview of elements and factors of both. These principles are:

1. Squash and Stretch

The tool that will require mastering as provides volume and weight to character. It helps define facial expressions and emotions. This is used in all animation frames and designs from speaking, to walking to a simple box moving.

Usage:

Understanding scale tool to determine up or down dimensions

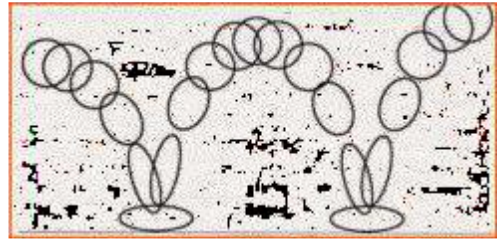

Fig.2.1.1: Squash and Stretch examples

2. Anticipation

If an action is to be at all dynamic in its movement and poses, the process of anticipation is important. The law of anticipation says that if an object is going to move forward, it must first move backward a little. Or, before moving.

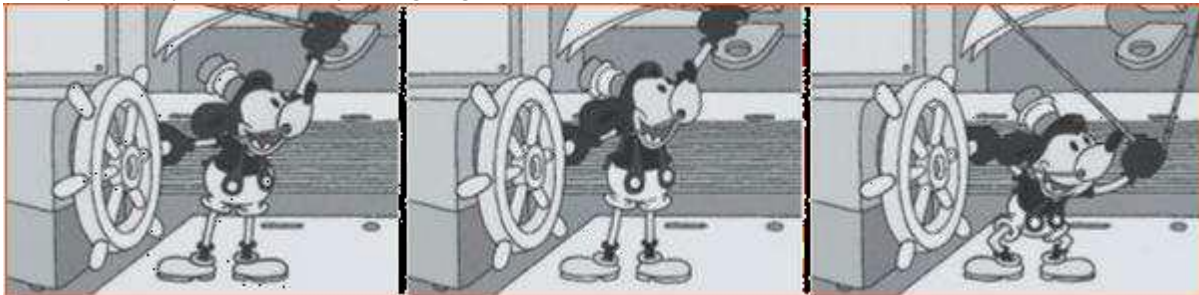

Fig.2.1.2: Anticipation Examples

Anticipation dictates that if a character is to move backward, it has to move forward first.

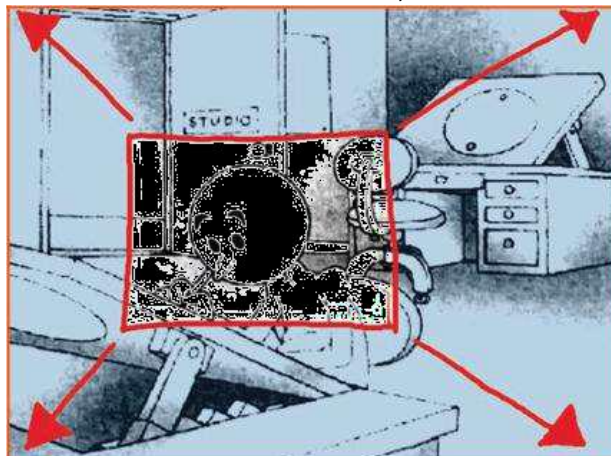

Fig.2.1.3: Anticipation dictates that if a character is to move backward, it has to move forward first.

3. Staging

When staging a number of shots that are derived from a single, large location, I prefer to sketch out a master shot of the full location, including the figures in it, first. This enables me to get familiar with its layout, size and the relationship or various settings and characters involved.

If animating within a complicated setting for a particularly large number of scenes, I may even build a simple cardboard cut-out version of the set and its characters. This becomes a valuable source of reference that can be studied from all angles when seeking interesting ways of staging and framing action scenes.



Fig.2.1.4: Staging and framing action scenes.

4. Straight Ahead Action and Pose-To-Pose Action

Straight ahead drawing follows a direct detailed process from end to end of a scene whereas Pose to Pose draws each relevant pose animation and then goes into detail of each as required.

5. Follow Through and Overlapping Action

Animation has to record a lot of detail movements. Sometimes the torso is constant but other parts of the body are in movement, like the arms, legs, hair, clothes etc. For eg: When Tom is chasing Jerry his four legs are in rapid movement. This is a follow through animation. A type of Drag action is when the parts of characters body do not synchronize with the body moving. Like the eyes of Roger Rabbit move out of the body and stay fixed on a thing, or imagine a dog chasing a car but when his body starts to run his ears and legs are still following, this effect is created using multiple frames per second and called Overlapping Action, these help create a real effect on character movements.

To note: Action remains continuous and does not end to create good animation

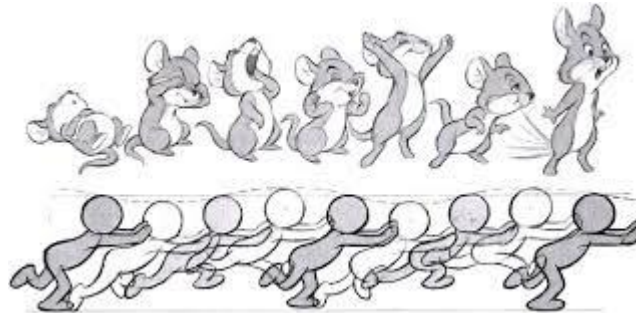

Fig.2.1.5: Overlapping actions

For Example:

- Hand throwing ball continues past release point
- To open door, reach for door before you finish walking

6. Ease In and Out (or Slow In and Out)

A great deal of movement requires either acceleration or deceleration in its action as nothing really moves evenly, except maybe machines. You will have to develop the ability to think of this chart-wise and accomplish it animation-wise. Nothing explains this process better than the classic bouncing ball.

The bouncing ball effect, illustrated in the figure below, is simple to describe. A rubber ball is thrown up, then lands and bounces high, then lands, then bounces not quite as high, then lands, then bounces even lower, etc., until it is out of energy and comes to rest. The principles described in this simple action define most of what animation is about. When thrown, the ball will accelerate into the air then slowly come to almost halt in midair as the forces of gravity exert an effect on it (1). Stopping for barely a moment, gravity will drag the ball back down to Earth again, accelerating as it does so. Then, hitting the solid ground (11), the ball will squash then spring upwards again. It will not rise as high as the first time, because the ground hit will have killed some of its velocity and the force of gravity will not allow it to climb or accelerate as much as the first time. It will again slow to a halt (19) and then accelerate downward again, where it will hit (29) and bounce up again (37), actually several times, each bounce successively smaller and smaller, until it finally comes to a halt.

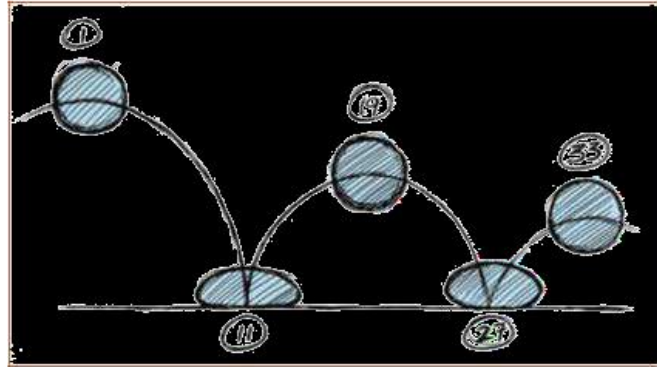

Fig.2.1.6: The standard bouncing ball.

7. Arcs

General curve element is used to create realistic body movements, even our arms and legs don't move straight or don't follow a perfect pattern, curves give the character a linear flow. For Eg : eating a bowl of soup.

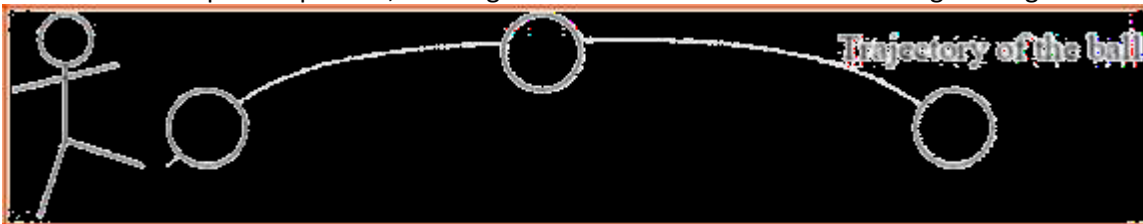

Fig.2.1.7: Kicking a ball

8. Secondary Action

Actions have different emotions and dimensions and must work simultaneously. A secondary action defines or enhances the main action, it is also a supportive element to better the character movement.

For example:

- Cord movement
- Facial expression



Fig.2.1.8: Cord movement

9. Timing

The right timing is the most important factor of animation. Time is the constant played around with to create the wanted effects on characters. Apart from slow and fast, time also determines accuracy to movement.

For Eg: A dog wagging his tail

A slow left to right movement of tail means relaxed

A fast movement means attention or listening

10. Exaggeration

The dramatic effect is given to certain characters to exaggerate their impact. Some broadened, wide stretches create good effects than the simplest monotonous effect on characters.

11. Solid Drawings

12. Appeal

Agreeable Attractiveness is crucial to any animation. Usually cartoons spring to our mind when we think of animation but only the funny characters is not just the essence, there are angry, villainous, friendly, different types of emotions and personalities that create a feature.

Modelling Process

3D modeling is a technique in computer graphics for producing a 3D digital representation of any object or surface. The 3D modeling process produces a digital object capable of being fully animated, making it an essential process for character animation and special effects.

Amongst the various design techniques used today, there are three most popular ones most commonly used:

Polygonal modeling: A Polygon has many point edges that can be connected using dots on the computer, it also has many sides that can help rendition better. Vertices in the 3D platform create a polygonal mesh that are used in singular or multiples curve shapes and are flexible to design.

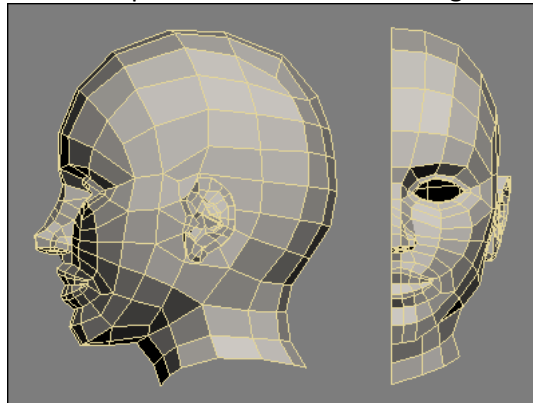

Fig.2.1.9: Polygonal Modeling

Curve modeling: Digital nonplanar curves are used with points that help determine structure based on the applied weight to points that comprise the curve circumference. The focus is not maneuvering effect through points that do not intersect.

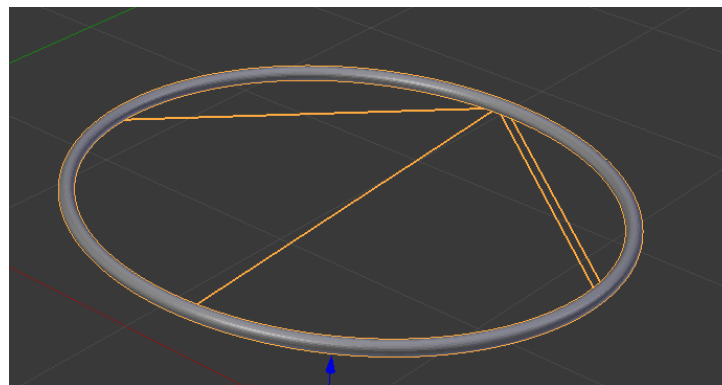

Fig.2.1.10: Curve Modeling

Digital sculpting: A recent entry into animation and new to use, however widely accepted at this earlier stage due to its flexibility and dynamic nature. This not only uses polygonal, curve technology modelling but creates high resolution image backups to track changes with data mapping.



Fig.2.1.11: Digital Sculpturing

Activity



Test your skills - OVERLAPPING ACTION exercise. Test your skills:

Have a ball bounce up and down in a cycle - then add a light skirt to the ball. Look for the “S” curves during the transitions of the skirt’s direction. ALSO: Try to DESIGN each shape of the skirt. Check your positive and negative areas.

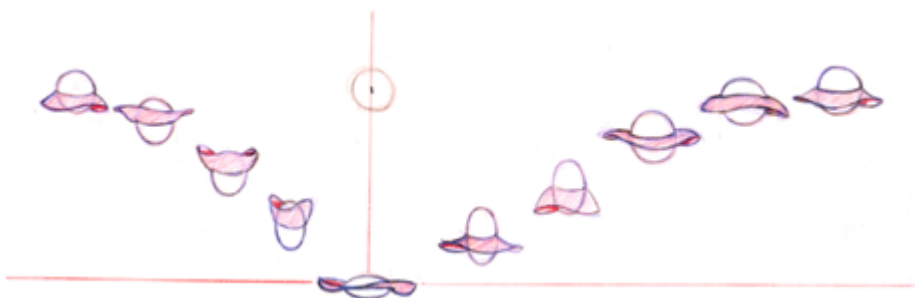

Notes for Facilitation



- Summarize the main points.
- Ask participants if they have any doubts. Encourage them to ask questions.
- Answer their queries satisfactorily.
- Tell participants to complete the questions at the end of the unit.
- Ensure that every participant answer all the questions.

Unit 2.2 Life Drawings: Human Anatomy Fundamentals (Script)

Unit Objectives

At the end of this unit, students will be able to:

- Elaborate fundamental script
- Demonstrate and analyze story Script
- Draw sketches as per script

Resources to be used

- Available objects such as black or white Board, chalk pieces or white board marker pens, duster.
- Job Card/Job description
- Pc with LCD Projector or Flip Chart.
- Participant Manual
- Copies of Handouts.

Do

- Greet and welcome the participants to the next session of the program.
- Before starting the session ask them to do, they have any doubts pertaining to the previous unit.
- Acknowledge their responses and clear their doubts if any.
- Tell them they will learn about Facial Expressions / movement / texturing and explain different type of eyes, Mouth, Nose, Emotions, Body expressions.

Say

Tell participants about the Facial Expression.

Elaborate

Expressions form the character of the model where unsaid things are communicated. Facial expressions communicate leaps if captured correctly. The first thing to draw our attention are one's expressions. The eyes, nose, mouth even eyebrows convey feelings. The face is an important nonverbal communication component.

Eyes Expressions

They say the eyes behold the maximum experience; they can change the entire created model. The eyelid, lashes and the pupil changes can alone create different expressions.

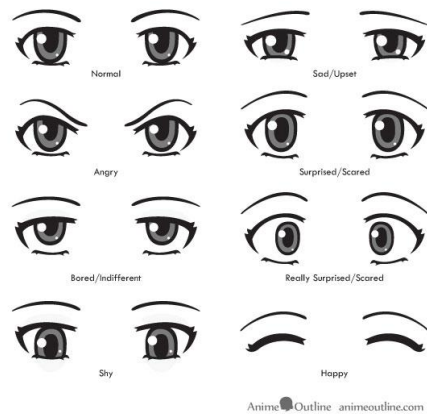

Fig.2.2.1: Eyes Expression

Mouth

This area plays with curves and is the second attention getter after the eyes. As detailed as types of lips, teeth structure, tongue can create different emotions.

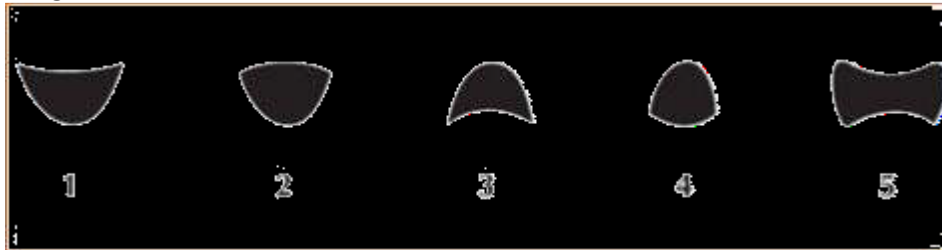

Fig.2.2.2: Lips move

- Both Up denotes happy
- Both down denotes sad, upset
- Upper down, lower up, mouth slightly open denotes laughing, happier can also mean astonishment when the jaw is open.
- Both pressed together denote suspicion, anger

Emotions

Below are detailed types of faces for understanding

The Relaxed Face

This is where the facial features remain constant without extreme alterations to them

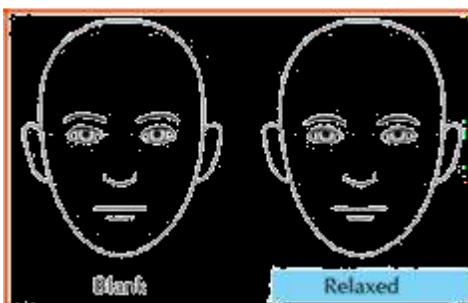

Fig.2.2.3: Relaxed Face

The Surprised Face

Is usually along with other actions, but a mild surprise to show emotions is by rounding features like the eyes and eyebrows.

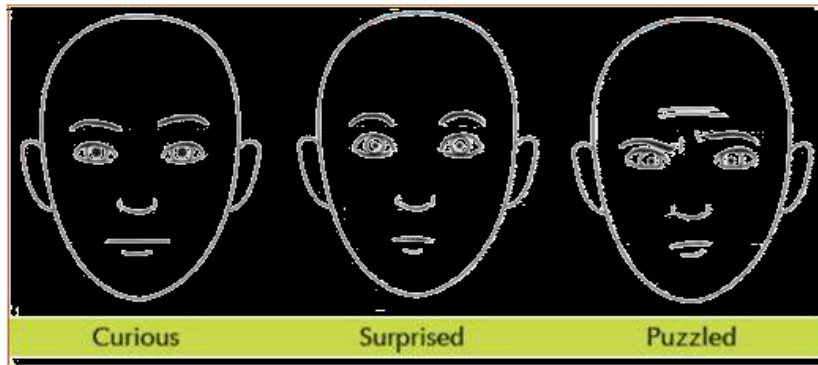

Fig.2.2.4: Surprised Face

The Angry Face

States strong emotions that are harsh and is showed by creasing the eyebrows, the more we contract them in middle the angrier the face. The pupils get darker.

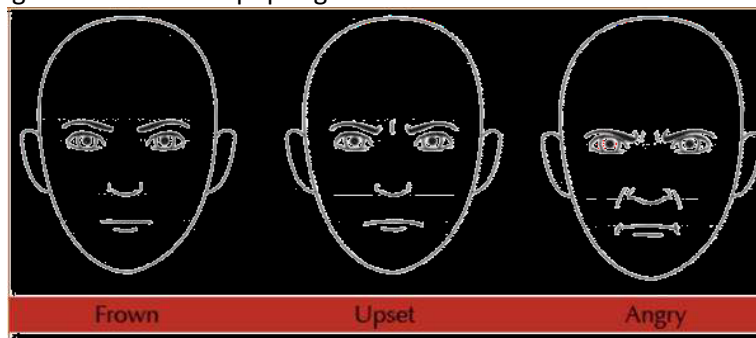

Fig.2.2.5: Angry Face

The Sad Face

All the curves are downwards in this, the brows, eyes look down, lips also curve downwards. With complimenting body like drooping shoulders add effects.

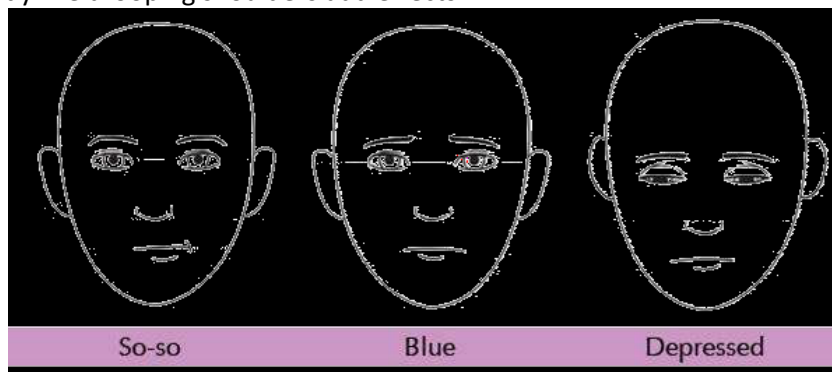

Fig.2.2.6: Sad Face

Body Expression

Body language is major component to nonverbal communication, even though expressions are controlled by body can convey subconscious thoughts or emotions. They will add on to character sketch. The hand gestures make a good difference if used correctly. Below are a few expressions to note:

Hand on Hips

Arm-Cross

Touching oneself

Activity

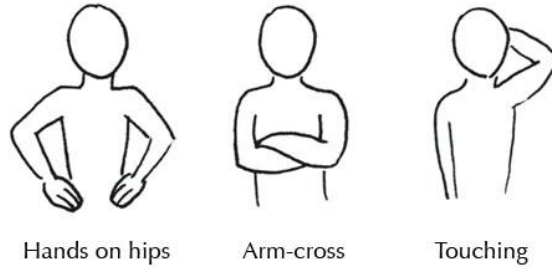
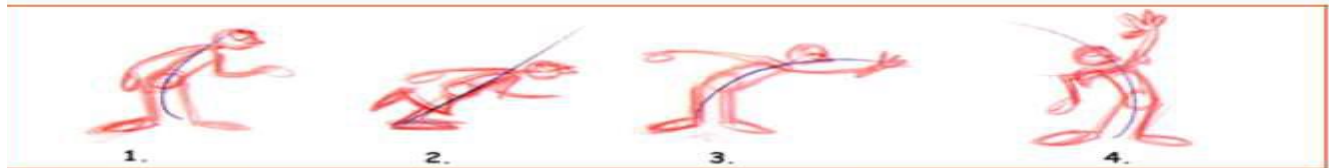

Fig.2.2.7: Body Expression

Step 1: Practice various body types to explore more nonverbal actions



Step 2: Create thumbnails and create a story or scene with upto 5 drawings with different expressions on same character.



Step 3: Always draw around Line of Action, to keep posture accurate to emotion

Step 4: A simple readable outline creates a good posture, the silhouette should be deciphered from any angle



Step 5: Once the Pose, line and Expression is set then add other elements to enhance the same, like the arms, hair etc.



Unit 2.3 Animation Production Process

Objective

At the end of this unit, you will be able to:

- Apply principles of production as per projects script.
- Use techniques available for animating objects for designing model
- Analyse Intellectual property rights.

Resources to be used

- Available objects such as black or white Board, chalk pieces or white board marker pens, duster.
- Pc with LCD Projector or Flip Chart.
- Participant Manual
- Copies of Handouts.

Do

- Greet and welcome the participants to the next unit of the program.
- Before starting the session ask them do, they have any doubts pertaining to the previous unit chart.

Say

- Pre-production and associated terms like storyboard, rigging, texturing, modelling etc.
- Explain production process and associated terms layout, animation, rendering
- Explain postproduction and associated terms like effects, compositing, editing,
- Explain different animation techniques

Elaborate

The initial stage where planning takes place that dictates the course of the animation. There are even dedicated companies coming up in this sector. Pre-production makes the process of film making structured and timely thus controlling costs.

The Idea: Every animation film, clipping or video is based on an underlying thought. It might be a single line that may have clicked to write a story on or a complete book. But to get the idea into effective outcome is important. Even a proverb pen is mightier than a sword can be an idea.

The Script: The narrative written document of the entire story sequence is called the script. The writer captures the essence of thought into elaborate writing, which describes characters, locations, camera framing and dialogues. The director then classifies it into scenes and shots.

The Storyboard: visual imagery of the script is created like a comic book where several panels illustrate scenes, character position and camera focusing. The production begins on approval of storyboard as both time and cost are affected if it needs major changes, minor changes can be required and are worked on throughout the production. Storyboard is the base to building.

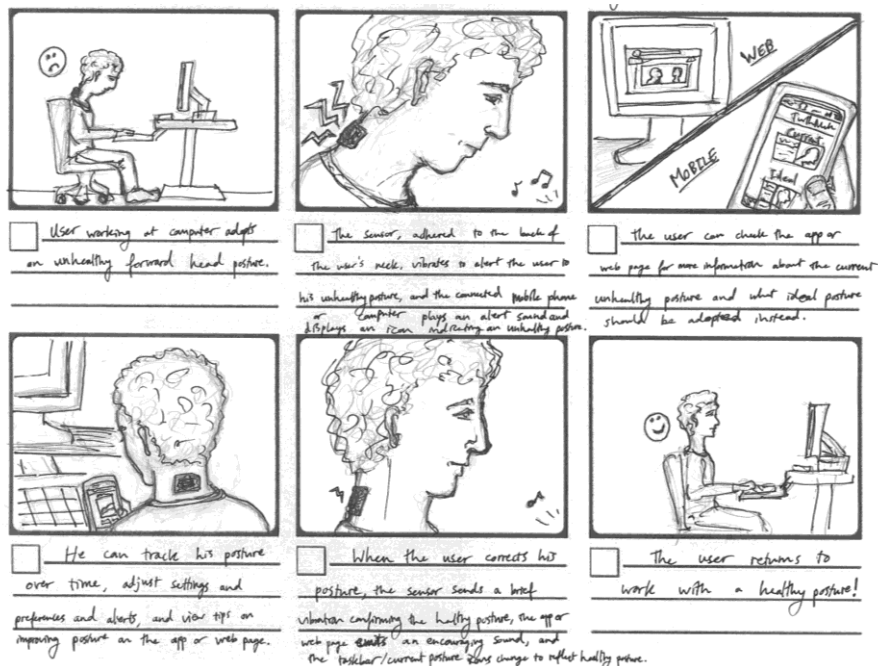

Fig.2.3.1: Storyboard

The Animatic: To understand the look and feel of storyboard, sound and dialogues are edited on panels, this makes easier changes if required. The Animatic works as a guideline to final in understanding the actual animation required for it. It may take up to weeks to put panels together along with edit and is based on budget of client.



Fig.2.3.2: Animatic

The Previsualization: A widely used technique by using digital stand ins or dummies to figure camera angles, lighting, frames, environment or movement in 3D space before actually starting the final product. This technique is used in 3D animation and features, to curb costs involved as changes can be done and issues be resolved before beginning the final work.

The Design: Design is a vast concept that includes sets, costumes, location environment to props to backgrounds. Design is a continuous process as it adds value, hence it needs to be worked real time as well to understand ambience. Design is sculpted digitally where concepts are painted to get the feel.

Explain - The Modelling:

- **2D (Limited):**

Basic character postures and poses are created in a way that when worked on can give a dimension to 2D as well. The human anatomy can be dissected into layers of elements.

- **3D:**

Various techniques to model like 3D scan, geometry rework, wire framing a mesh are used on 3D elements if any in production. Sometimes characters are made as puppets with clay or pop decorated with hair or clothes. Environments can be created using wood or paper. This takes up to two weeks to months depending on details. It's charged per model made or on hourly rate of work.

The Rigging:

- **2D (Limited): A**

The characters body must be in puppet like separated elements, the arms, legs, hands etc. Like the wrist is connected to the forearm, which joins the elbow then the shoulder. These joints have pivot points that can be adjusted or rotated as required.

- **3D:**

3D mesh bends and folds are used to create bones, hair, muscles, eyes and clothes once the character model is made. It is tedious and intricate to get the desired outcome. Stop Motion: Armatures are used to hold clay or mesh models that are nothing but aluminum or wire skeletons.

The Texturing:

- **2D:**

Textures can be complex or simple depending on the model, simpler ones are flat using gradient textures, but complex ones need to have ability to move with the model.

- **3D:**

Texturing is color, gradient, hand painting or digital imagery. Even photographs can be digitally used as textures, this enables innovative surfaces and designs. Lighting behavior like reflection, shadows and bouncing off is also texture control.

- **Stop-Motion:** Gradience or textures are hand done on puppets and models.

- **Time Involved:** Texturing takes anytime between minutes to months to create depending on simple coloring to complex creation. It is charged per model or on hourly rate of artist.

- **Cost Involved:** Based on per model or per hour of work charge.

Production

Once the script is finalized, the design and storyboard approved the final work towards its creation starts. Usually, begins at slow pace but picks up momentum and is fastest at the end. The time frame and cost depend on how much effort and attention went into pre-production.

The Layout

Layouts are based heavily on Illustrations than the storyboard alone.

- **2D:** A hand painted background is used wherein the animation character must be within that background which later will be painted.

- **3D:** Usually done during pre-visualization, models and characters are placed in 3D space with camera to understand motion and give better modelling opportunity to designers.

Stop-Motion: The use of puppets already has models ready for camera movement, as they are on the actual set, they need correct lighting to get the plot for camera motion.

Post- Production

When the final scripting, animation and rendering is done the details are then added like audio, special effects, dialogues etc. to complete it. It's like chiseling a made sculpture to perfection.

The Effects: A Effects vary from glowing insects to flying airplanes, to creating shadows or adding glittery backgrounds, sometimes as simple as expanding backgrounds or making night turn day, even elemental 2D effects like air, water, fire as used in combinations.

The Compositing: Compositing just like name suggests is layering several images into final work. Although it is the end process, the right effects occur through compositing, just like removing green screens, color correction and roscope masking sound basic the task is of art.

The Editing: Editing is a continuous process and works through pre to postproduction editing each scene in detail and final minute touches.

The Audio: Sound is a crucial part as it adds the mood and feel, scratch audio is like dummy audio that is added to understand the effect And setting time. Well known professionals are considered as 70% movie is conveyed through final audio. Song writers, composers and Sound engineers work together to write, play the score and mix in efficiently.

Demonstrate



Demonstrate rigging to participants using examples.

Starting with basic skeletal animation, demonstrate rigging the character according to the specifics set up by the tool.

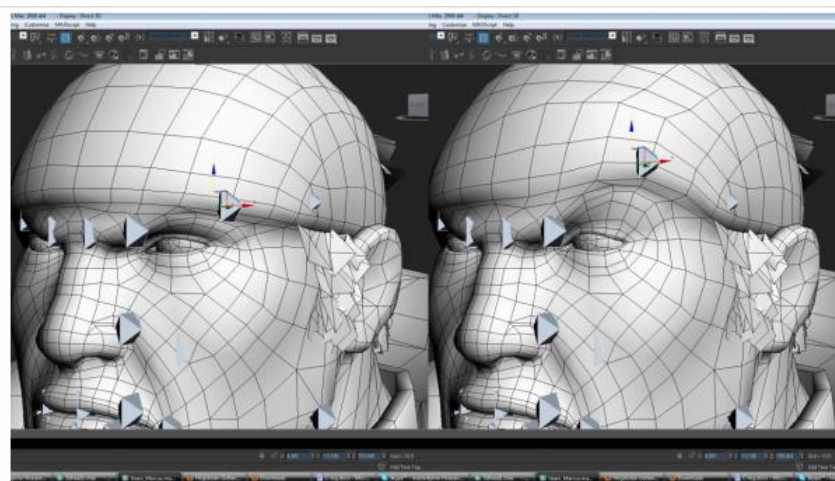

Picture 1.1: This is the reference model I used. On the left picture the bones are untouched and on the right picture I have raised the eyebrow bone. The rig reacts as it should and no problems show up. This rig has same kind of hierarchy as my own facial rig I constructed.

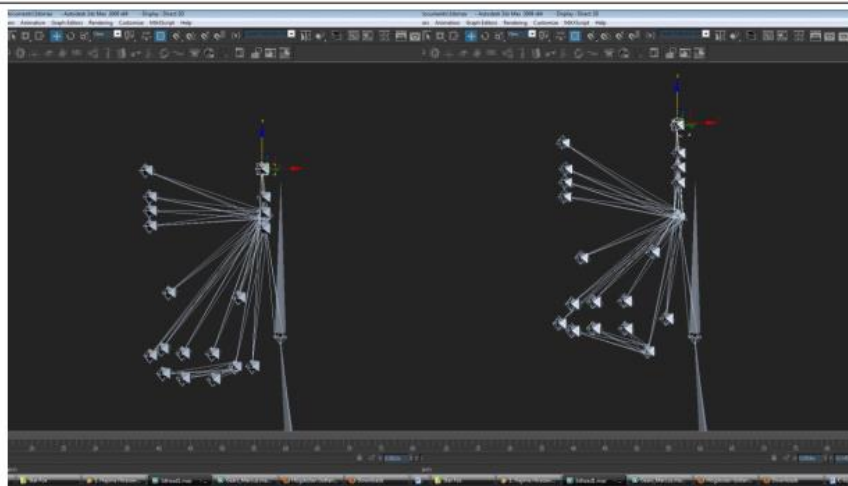

Picture 1.2: The first facial rig I built. On the left picture the rig is untouched. On the right picture I have attempted to raise the eyebrow bone, but the entire rig reacts to the movement and the whole face is consequently raised, unlike on the reference model. It should be noted that both the reference rig and this facial rig I built has the same kind of hierarchy.

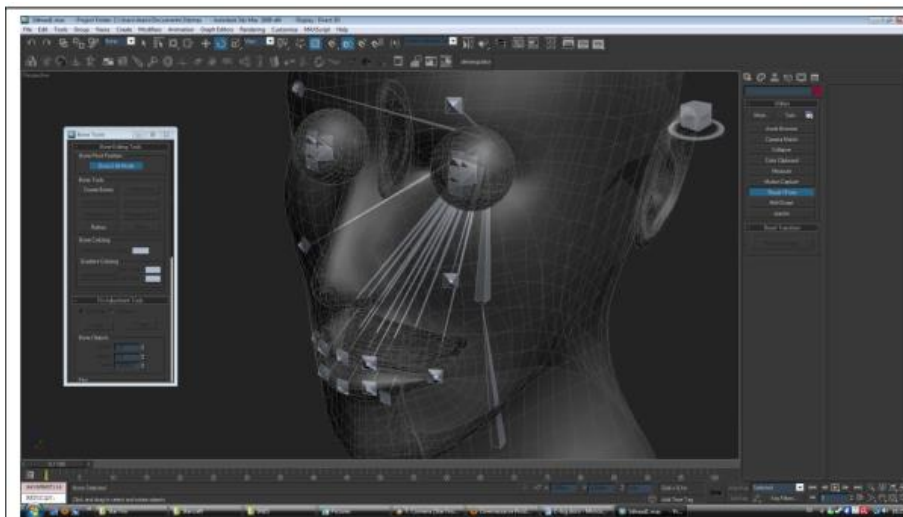

Picture 2.1: This is the finished Skeletal Animation rig, with the model attached.

Notes for Facilitation



- Summarize the main points.
- Ask participants if they have any doubts. Encourage them to ask questions.
- Answer their queries satisfactorily.
- Tell participants to complete the questions at the end of the unit.
- Ensure that every participant answer all the questions.

Unit 2.4 Create Hookup Poses and Animation

Objective

At the end of this unit, you will be able to:

1. Enact and emote poses
2. Create Hookup Poses and Animation.

Resources to be used

- Available objects such as black or white Board, chalk pieces or white board marker pens, duster.
- Pc with LCD Projector or Flip Chart.
- Participant Manual
- Copies of Handouts.

Do

- Greet and welcome the participants to the next unit of the program.
- Before starting the session ask them do, they have any doubts pertaining to the previous unit chart.

Say

- Explain what is hook up poses and its uses.

Elaborate

Hook up pose is the in between hold between movement of character from one scene to another. To ensure that the pose is fluid and matches without errors frame to frame. Hence pre-production plays an important role, as storyboarding needs to ensure that cartoons have no continuity errors.

Before animation begins. Animation is vast and requires many designers to be working on different frames, nothing guarantees matching apart from hook up poses.

See the below instance to understand errors in fluidity of scenes:

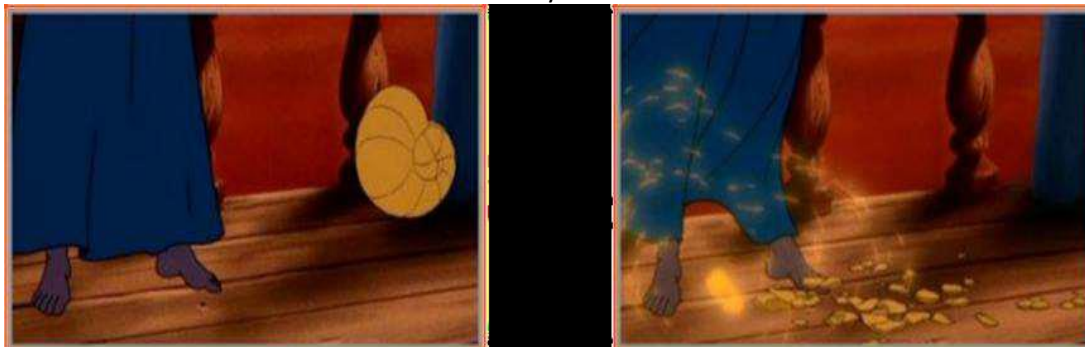

Fig.2.4.1(a): The Hook-up Pose Fig.2.4.1(a): The Hook-up Pose - Errors

Little mermaid is with bare feet and then is wearing shoes.

Learning: proper written costume follow has to be made, even though can be missed in seconds.



Fig.2.4.1(c): The Hook-up Pose - Errors

Check one more! Ursula's pose in the first and next is complete different even the hold on Ariel has changed. The speed totally makes viewers overlook this. Then Ariel being a mermaid is fully dressed when Ursula attempts jumping over the railing, then next we see Eric watching over the ocean.



Fig.2.4.1(d): The Hook-up Pose - Errors

Cuts to Ursula forcibly taking Ariel but now the mermaid has changed attire.



Fig.2.4.1(e): The Hook-up Pose - Errors

A proper reasoning could have been applied here by showing clothes floating after they jump or being torn in the drag.



Fig.2.4.1(f): The Hook-up Pose - Errors



Fig.2.4.1(g): The Hook-up Pose - Errors



Fig.2.4.1(h): The Hook-up Pose - Errors

Demonstrate



Explain hook up poses.

Demonstrate various scenes to understand errors in fluidity:

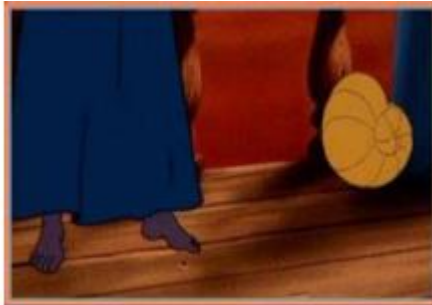

Fig.2.4.1(a): The Hook-up Pose



Fig.2.4.1(a): The Hook-up Pose - Errors

Notes for Facilitation



- Ask participants if they have any doubts. Encourage them to ask questions.
- Answer their queries satisfactorily.
- Tell participants to complete the questions at the end of the unit.
- Ensure that every participant answer all the questions.



Skill India
कौशल भारत-कुशल भारत



सत्यमेव जयते
GOVERNMENT OF INDIA
MINISTRY OF SKILL DEVELOPMENT
& ENTREPRENEURSHIP



N · S · D · C
National
Skill Development
Corporation

Transforming the skill landscape

3. Prepare Computer Generated Models

- Unit 3.1 Create Prototypes/Pilots for Testing
- Unit 3.2 Produce 3D Animation, Pipeline and Modeling
- Unit 3.3 Creating, Manipulating and Viewing Objects
- Unit 3.4 Viewing the Maya 3D Scene
- Unit 3.5 Polygonal Modelling
- Unit 3.6 NURBS Modeling
- Unit 3.7 Animation

Key Learning Outcomes



At the end of this module, you will be able to:

- Describe the ideas like polygons, nurbs, and sub surface modelling etc.
- Draw sketches of elements of model in specific proportion
- Style the model as per the script
- Demonstrate the utilization of assorted modelling software package and tools
- Prepare priority sheet as per the deliverables
- Produce listing and verify all steps
- Outline kind, scale and proportion of assorted model or its individual elements.
- Produce varied components/parts of model
- Demonstrate the method of making 3D primitive objects
- Outline the various ways that of modeling - plane figure modelling, nurbs modelling or the surface modelling, etc.
- Demonstrate the method of planning 3D models victimization 3D primitive objects (interior and exterior environment)
- Produce character design/frame and structure the character as model
- Produce the visual variety of the project, together with color sets, mood, etc.
- Determine elements for re-designing and piece of writing functions
- Describe the importance of maintaining the sting topology whereas making ready the models
- Demonstrate the steps concerned in checking for any penetration or overlap in texturing or in animation.

Unit3.1: Create Prototypes/Pilots for Testing

Unit Objectives

At the end of this unit, students will be able to:

1. Elaborate the pipeline, schedule and timelines of the projects.
2. Create Prototypes/Pilots

Resources to be used

- Available objects such as black or white Board, chalk pieces or white board marker pens, duster.
- Pc with LCD Projector or Flip Chart.
- Participant Manual
- Copies of Handouts.

Do

- Greet and welcome the participants to the next unit of the program.
- Before starting the session ask them do, they have any doubts pertaining to the previous unit.
- Acknowledge their responses and clear their doubts if any.
- Tell the participants they will learn about Prototype Testing.

Say

Tell participants about Prototype Testing.

Elaborate

Create Prototypes for testing:

A prototype is an initial idea to understand how final medium will function during production. Its build with specifications by client to give look and feel and to change accordingly, and a glimpse of current system. This helps understand functionality and system requirements.

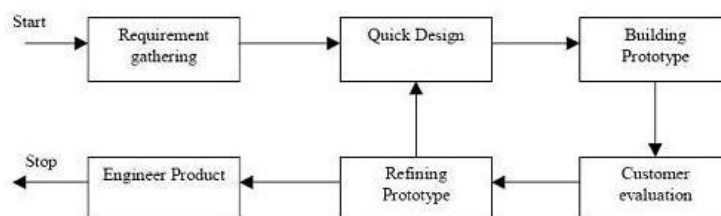

Prototyping Model

Fig3.1.1: Prototype Model

Prototype model diagram:

- Advantages of Prototyping
- Client in depth understanding
- Good involvement as a dummy working system is showcased
- Timely corrections
- Speedy approvals
- Quick error identifications
- Touch and Feel helps understand better
- Faster validation leads to project implementation

Disadvantages of Proto-typing:

- Earlier creation leads entire repair for single error
- Extensive application of system distorts originality
- Full system use to creation leads to missing out on application unfinished
- Not sturdy feedback and concrete analysis

When to use:

- For excessive involvement of clients
- Web interfaces and Online Applications work best as have maximum interactions and system integration requires least supervision to Modellers
- Requires constant feedback to correct and improve hence users must be actively accessing the system, hence human interfacing is excellent. Note that polycounts, mesh compatibility and movement capacity should be checked for accurate adaptability to final display, ensuring working when animated and performance remains same.

Activity



1. Divide the class in two and ask one set to list advantages and the other, the disadvantages of Prototyping.

Notes for Facilitation



- Ask participants if they have any doubts. Encourage them to ask questions.
- Answer their queries satisfactorily.
- Tell participants to complete the questions at the end of the unit.
- Ensure that every participant answer all the questions.

Unit3.2: Produce 3D Animation, Pipeline and Modelling

Unit Objectives

At the end of this unit, you will be able to:

- Produce 3D Animation
- Produce Pipeline and Modelling
- Explain the concept of pipelining and modeling.

Resources to be used

- Available objects such as black or white Board, chalk pieces or white board marker pens, duster.
- Pc with LCD Projector or Flip Chart.
- Participant Manual
- Copies of Handouts.

Do

- Greet and welcome the participants to the next unit of the program.
- Before starting the session ask them to do, they have any doubts pertaining to the previous unit.
- Acknowledge their responses and clear their doubts if any.
- Tell the participants they will learn about Maya Software.

Explain

- Explain Maya software
- Explain various commands in details for creating animation in Maya
- Pipeline and Modelling concept
- Using pipeline and modelling in Maya

Elaborate

Maya User Interface

Amongst the many tools for software interface Maya is a leading one that helps generate 3D models. It has tools and editors that enable creating, animating and rendering 3D objects, also effects and scene manipulation can be done with this.

Starting Maya

Double click on Maya icon on desktop or select from Microsoft (2000 or XP) Professional Start menu from Programs to Autodesk to Maya 2008 (Complete or Unlimited), on IOS select on desktop or in the Dock, else in the Apple finder go to application and browse. In Linux if not on desktop type Maya in shell window

Learning the Maya interface

- Work with menus.
- Use the Status Line buttons.
- Access the Shelf.
- Explore the Channel Box and Layer Editor
- Understand controls, commands

Demonstrate



Work with menus

Always begin with main menu as a beginner, they have text lists and easy to learn. Explore the submenus that are small arrows at end of menus.

Changing Menu sets

Using the drop down list at the extreme left you can customize menu sets. You can select from Rigging, Animation, Rendering etc. and change as required. Each has an associated hotkey, like F5 for FX. You can check them right next to menu that is opened and customize them in Hotkey Editor. Find the same with Windows,

Settings to Hotkeys menu. Using them makes it easier and faster to use interface. The first six commands are present in all sets, File, Edit, Modify, Create, Display and Window.

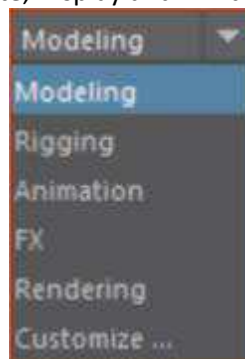

Fig3.2.1:Menu Sets

Viewing Keyboard Hotkeys

Several menu commands have a keyboard hotkey listed to the right of the menu, as shown in Figure 1-2. Pressing these hotkeys on the keyboard executes the command. Hotkeys provide a quick and easy way to execute a command, and learning to use them will make you much more efficient.

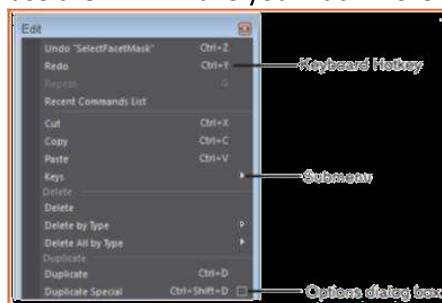

Fig.3.2.2: Figure 1-2

Accessing Option Dialog Boxes

There is options dialogue box that give you changeable parameters, included as small boxes on right in some menus.



Fig.3.2.3: Figure 1-3

Creating Polygon Sphere

Step 1: From create menu, select submenu polygon primitives to then click on Options icon to open dialogue box.

Step 2: click on Apply button, a single sphere object will appear on workspace.

Step 3: Exit the box with Close.

Step 4: Go back to Cone Menu in Submenu Polygon Primitives. A cone will appear over sphere.

Step 5: On pressing key 5 objects appear shaded and resemble crystal ball.

Step 6: To Save, go to File and Save Scene As.

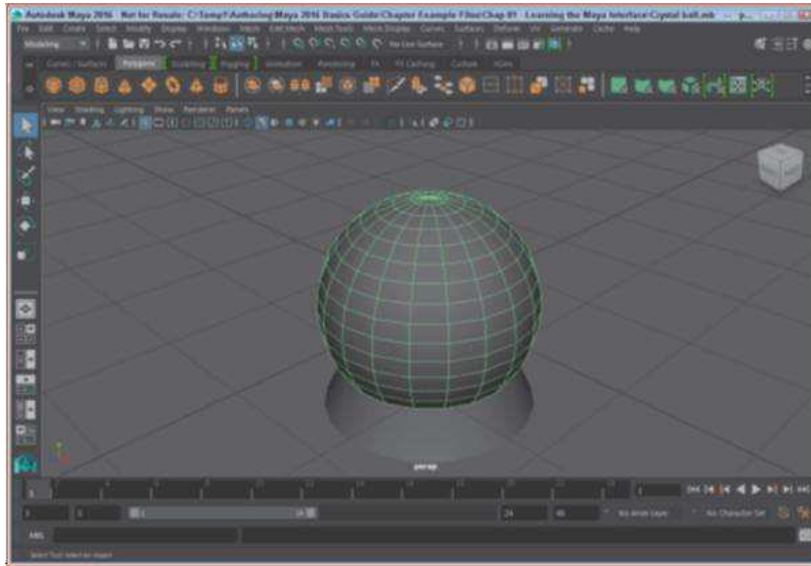

Fig.3.2.4: Figure 1-4

Explain - Working with NURBS Surfaces

NURBS is an acronym for Non-Uniform Rational B-Spline. These splines are mathematically defined lines that you can manipulate to form unique shapes. A NURBS surface is a solid object created from NURBS curves. NURBS surfaces are useful for modeling organic objects like flowers and trees where the surfaces flow into one another.

NURBS surfaces, like NURBS curves, can be edited by moving their control vertices (CVs). You can also display hulls for the NURBS surfaces to see how the various CVs are connected. Using the right-click marking menu, you can select to see all the components that make up a NURBS surface.

View an Animation

Spending a lot of time rendering a final animation only to find out that you've made a mistake can be time consuming and frustrating. Previewing animations can help eliminate mistakes early on.

Pipeline and Modeling

A pipeline is a working schedule with concerned team members for deliverables, includes timelines and is a path to follow while creating animations. You can call it a flow chart.

Modeling is the creation of the object or environment mesh in 3D. As with all of the other stages, the type of work may be split into smaller subgroups. For example, one person may model props, another may model Hero (a.k.a. main) characters, and still another might work on just the environments. Whatever needs to be modeled, though, it is done during this stage.

Demonstrate



Demonstrate the NURBS Primitives

The simplest NURBS surfaces are the primitive objects that can be created using the Create, NURBS Primitives menu. The NURBS primitives include the sphere, cube, cylinder, cone, plane, and torus (which is shaped like a doughnut), as shown in Figure. When selected, the primitive object appears at the grid's origin.

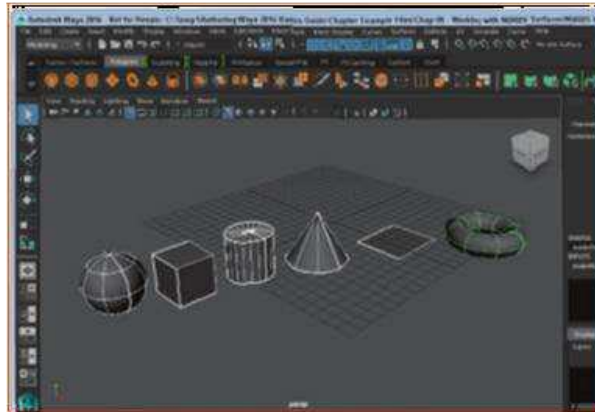
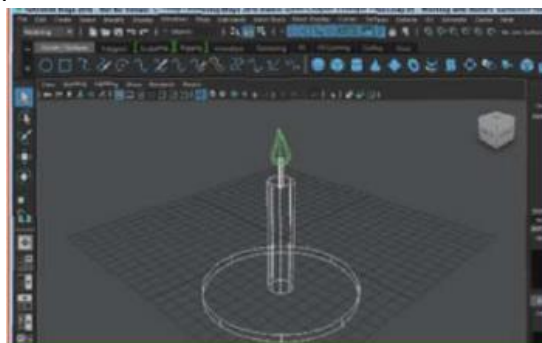

Fig.3.2.5: NURBS Primitives

Create a Candle from Primitives

- Step 1:** Click on the Four Views button in the Quick Layout Buttons.
- Step 2:** Select Layout type in Quick Layout button
- Step 3:** Click on the Scale tool and drag the green Y-axis manipulator to increase the cylinder's height.
- Step 4:** Create another cylinder object using the Create, NURBS Primitives, Cylinder menu command.
- Step 5:** Drag the center handle in the Top view with the Scale tool to reduce the diameter of the cylinder, and then drag the green Y-axis manipulator upward to lengthen the cylinder. Select the Move tool and drag the green Y-axis manipulator to move the small cylinder to the top of the larger cylinder. The larger cylinder is for the candle and the smaller cylinder is the wick.
- Step 6:** Create another cylinder object using the Create, NURBS Primitives, Cylinder menu command.
- Step 7:** Drag the center handle in the Top view with the Scale tool to increase the diameter of the cylinder, and then drag the green Y-axis manipulator downward to reduce the cylinder's height. Select the Move tool and drag the green Y-axis manipulator to move the large flat cylinder to the base of the candle.
- Step 8:** Create a sphere object using the Create, NURBS Primitives, Sphere menu command.
- Step 9:** Select the Move tool and drag the sphere upward in the Front view to the top of the candle wick.
- Step 10:** Click on the Select by Component button in the Status Line.
- Step 11:** Drag over all the top CV points in the Front view and move them upward in the Front view using the green Y-axis manipulator.
- Step 12:** Select the very top CV point on the sphere and drag it up and to the left in the Front view. The edited sphere looks like a simple candle flame, as shown in Figure and save the file in Save Scene As, Name the File .



Candle Primitives

Explain: Pipeline and Modeling

A pipeline is a working schedule with concerned team members for deliverables, includes timelines and is a path to follow while creating animations. You can call it a flow chart.

At any given time, you should be able to locate art assets. Thus it is very important to become familiar with how production pipelines work.

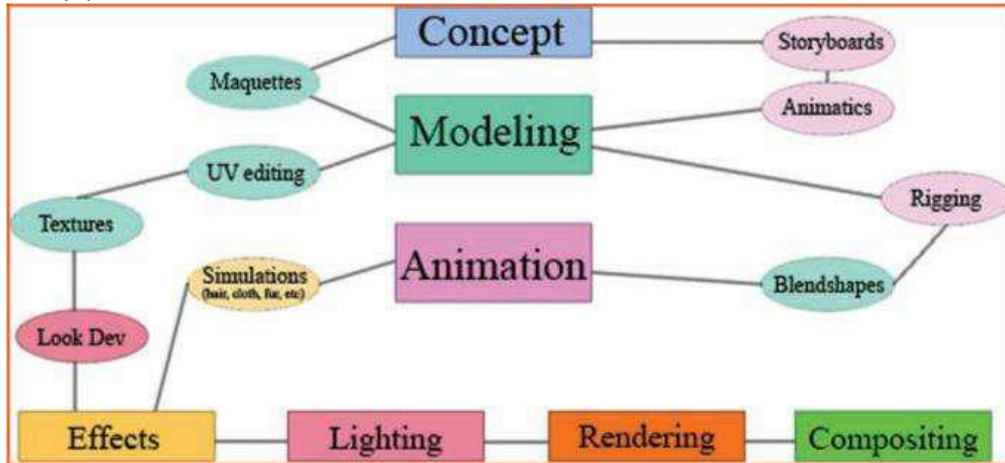

The modeling process

Following shows simple pipeline. On large productions, each of these jobs could be further broken down into separate tasks. However, even on large productions, the goal is to make the process of getting assets into the game or movie as pain-free as possible. Often times, a model will need to go through the pipeline multiple times (if something needs to be changed, for instance) and having a smooth process to facilitate this is vital. Now that we can see how important it is to work within a pipeline, how can that be transferred over to Maya? Maya has very simple, yet complete project tools to help set up and manage your own pipeline. In Maya these are called projects.

To set up a new project go to:

1. File Project New.
2. In the Project Setting window, type a name for the project and set a path.
3. Next click Use Defaults. It's advised to always select. Use Defaults as this will allow Maya to organize all the assets for the project.
4. Click Accept. You now have a new project and are ready to work.

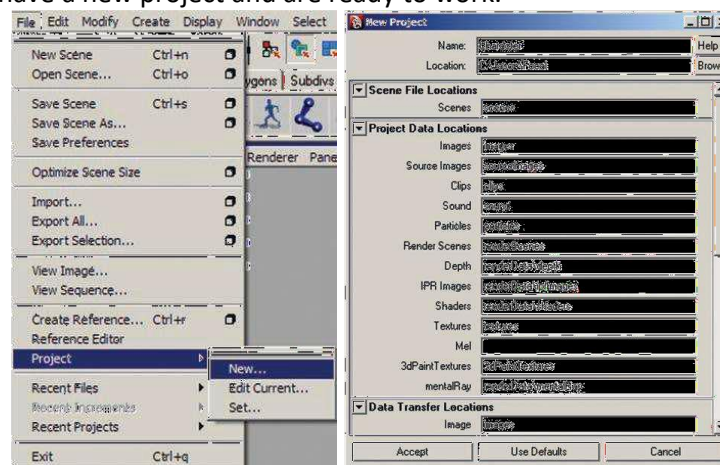

Open a new project

Open a new project

Unit 3.3: Creating, Manipulating and Viewing Objects

Objectives

At the end of this unit, you will be able to:

- Create three dimensional models
- Select and work on Models
- Apply motion with mouse in creation of 3D primitive objects

Resources to be used

- Available objects such as black or white Board, chalk pieces or white board marker pens, duster.
- Pc with LCD Projector or Flip Chart.
- Participant Manual
- Copies of Handouts.

Do

- Greet and welcome the participants to the next unit of the program.
- Before starting the session ask them to do, they have any doubts pertaining to the previous unit.
- Acknowledge their responses and clear their doubts if any.
- Tell the participants they will learn about Creating Objects.

Say

Tell participants about Im-primitive Objects, Different 3d Models.

Elaborate

Creating a new scene

Make a new scene in order to create a new project, for doing this:

- Start Maya

It will already create a new scene, if already running delete previous scenes by selecting no when pop up prompts saving it while you attempt to create new one

- Choose new scene options from the file menu
- This message is shown:

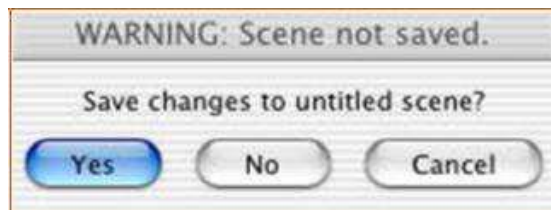

Fig.3.3.1: Saving Scene

- Choose No option and new scene is created

Demonstrate



Primitive Objects

Primitive objects in Maya are shapes like polygon, cube, cylinders and cones.



Fig.3.3.2: Primitive Objects

To create a polygonal cylinder for the base

- Polygons menu set is selected.
- Choose cylinder, from polygon primitives under create option. A new window prompt comes up
- Choose edit and then reset setting option under Polygon Cylinder and put these numbers
 - a. Radius= 10
 - b. Height= 1
 - c. Height divisions= 1
 - d. Axis divisions= 8
 - e. Cap divisions= 1
 - f. Axis= Y
- Now choose create option under the Polygon Cylinder.
- Now octagonal shaped primitive object of cylindrical shape is created. It has 8 sides, width is 20units and height one unit

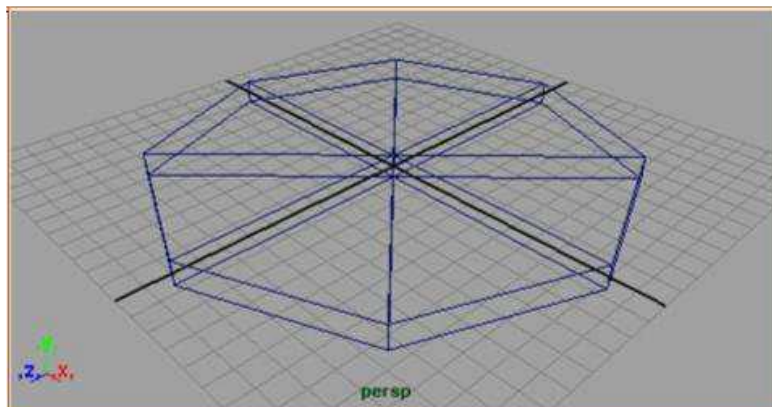

Cylinder

Demonstrate



The Channel Box

Chanel Box may be used for changing details (x, y values) of object by changing values. This may be used for Translation rotation.

To move and rotate the base using the Channel Box

- Transformation attributes may be seen in channel box
- Change these values so that they Make above image similar to above image and enter number values
- Software automatically names a file, it may be renamed

For renaming

- Choose name filed (pCylinder1)
- Rename this with more meaningful name.

Unit 3.4: Viewing the Maya 3D Scene

Objectives

At the end of this unit, you will be able to:

- Apply 3D animation techniques on Maya software-viewing the Maya 3D Scene.
- Identify and use of camera tools.
- Analyse overview of workflow.

Resources to be used

- Available objects such as black or white Board, chalk pieces or white board marker pens, duster.
- Pc with LCD Projector or Flip Chart.
- Participant Manual
- Copies of Handouts.

Do

- Greet and welcome the participants to the next unit of the program.
- Before starting the session ask them do, they have any doubts pertaining to the previous unit.
- Acknowledge their responses and clear their doubts if any.
- Tell the participants they will learn about different view in Maya.

Say

Tell participants about different view in Maya.

Elaborate

Camera tools

There are two views discussed and seen in above chapters, one seen was the orthographic view that is 2D images and second is Perspective view which is 3D. The orthographic view considers only 2 axis whereas perspective considers 3. The interface shows you how scenes look from camera.

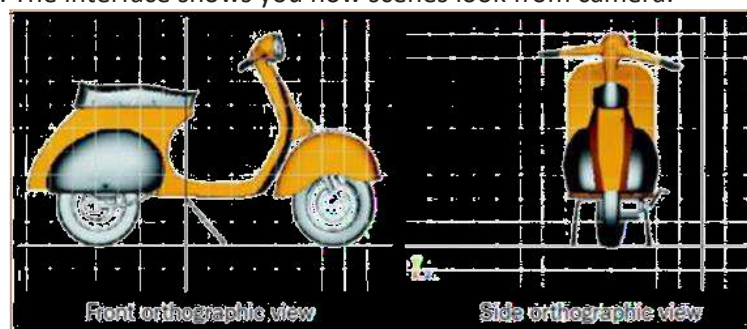

Fig.3.4.1: 2 Axes View

Demonstrate



Workflow Overview

A group of primitive shapes design the pillars of temple, like the base was duplicated we will apply the same process to all pillars.

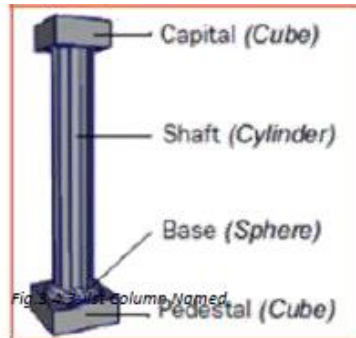

Fig.3.4.2: 1st column named

To create a polygonal cube for the pedestal

- Select Create, Polygon primitives and Cube
- Open Options for object and enter values as:
 - a. Width= 1.75
 - b. Height= 0.6
 - c. Depth= 1.75
 Other values are left same

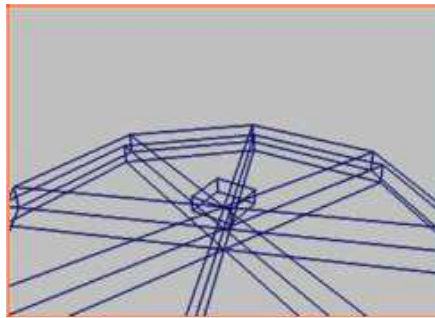

Fig.3.4.3: Polygonal cube for the pedestal

Creating cube primitive at origin

This will be placed at the origin, using side view Move the cube so it sits on the base. Save the object by Renaming.

To create a polygonal cylinder for the shaft

- Create, Polygon primitives and Cylinder.
- Reset Settings with below values:
 - a. Radius= 0.5
 - b. Height= 6
 - c. Axis divisions= 1
 - d. Other values are left same

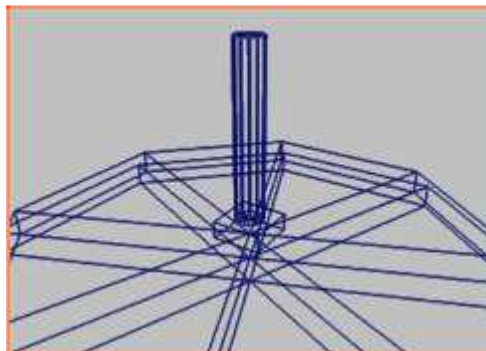

Fig.3.4.4: Polygonal cylinder for the shaft

Demonstrate



Pivot Points

It is used as reference point along with other objects (curves, surfaces, and groups) are transformed.

To group the two columns

- Once the column are selected by the specific positions go to Edit, Reset the settings. Select parent for group
- In the Group Options window, click Group.

Software automatically has the pivot points at the origin for an objects that have been grouped

To duplicate and rotate the group

- Go to Edit, duplicate special and Reset settings to Rotate (90) and copies at (3)

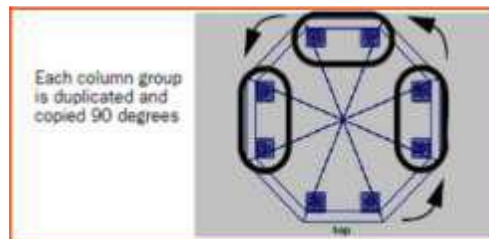

Fig.3.4.5: Rotate the Group

- Duplicate Special, in Duplicate Special prompt. Duplicated copy is created and rotated by 90 deg.

Demonstrate



Components

- All objects are provided with shape & transform node.
- For modifying shape, you need to change information of component.

Selecting components of entablature

- Dolly in in order to get close view of Entablature, in side view.
- You need to Transform in Component View. Once Selection mode is at Component right click the Created roof and go to Control vertex.
- A new menu pops up, this is for selecting operations for object by right clicking
- Pool a Selection box across the top row and pool the vertices.
- With help of Move Tool, Change shape of Entablature by vertically moving up vertices.
- Click on the wireframe to get back to object mode.

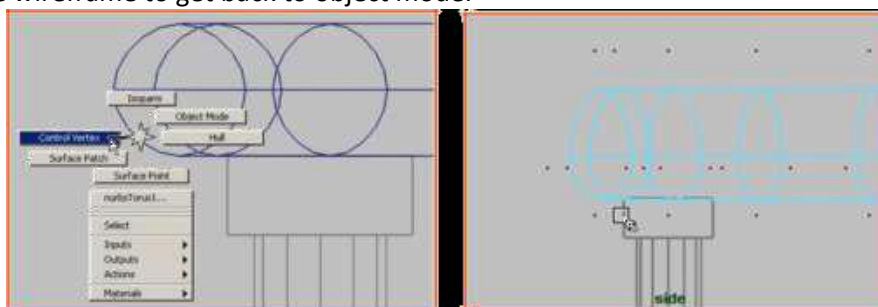

Fig.3.4.6: Components of the entablature

Unit 3.5: Polygonal Modelling

Objectives

At the end of this unit, you will be able to:

- Apply 3D animation techniques on Maya Software-Polygonal Modelling.

Resources to be used

- Available objects such as black or white Board, chalk pieces or white board marker pens, duster.
- Pc with LCD Projector or Flip Chart.
- Participant Manual
- Copies of Handouts.

Do

- Greet and welcome the participants to the next unit of the program.
- Before starting the session ask them to do, they have any doubts pertaining to the previous unit.
- Acknowledge their responses and clear their doubts if any.
- Tell the participants they will learn about Modelling process in Maya.

Say

Discuss about Modelling Process using Maya.

Elaborate

The accuracy and Artistry required for designing the making the shape and structure detail and proportionate is called Modelling.

3 kind of modeling surface are there in Maya software:

1. Polygons
2. NURBS
3. Subdivision surfaces.

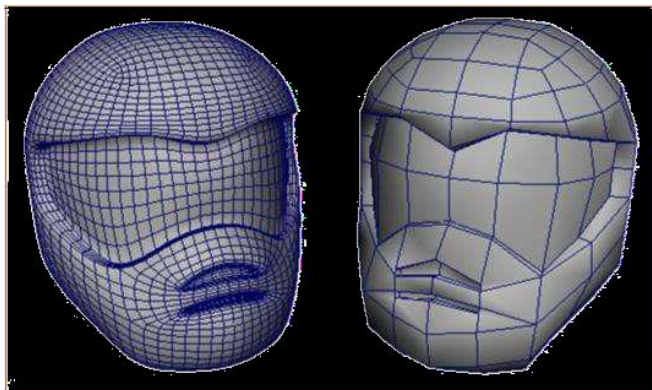

Fig.3.5.1: Modeling surface

Demonstrate



Modeling in shaded mode

3D volume is better understood by modeling the polygon mesh in shaded mode.

you can select the different display options like the orthographic mode for wireframe and perspective for shaded

Showing helmet mesh in Wireframe (in Shaded mode)

- Follow the instructions of Right Click on the mesh and select the view from the object mode.
- Select the helmet mesh.
- Perspective view select shading, smooth shade and with the same pathway Select Wireframe

Displaying the helmet mesh in shaded X-Ray mode

Helmet being selected, choose below from side view's menu:

- Choose 'smooth shade all' in shading
- Choose 'Wireframe on Shaded' in shading
- Choose 'X-Ray'.

helmet mesh is updated to semitransparent shaded display having wireframe. 2D image can be seen behind mesh.

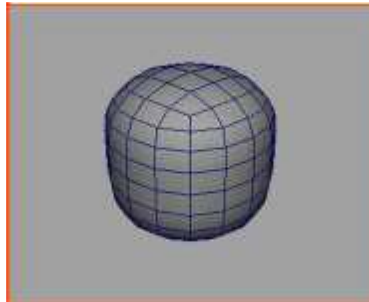

Fig.3.5.2: Shaded X-Ray mode

Repeat this for other view as well

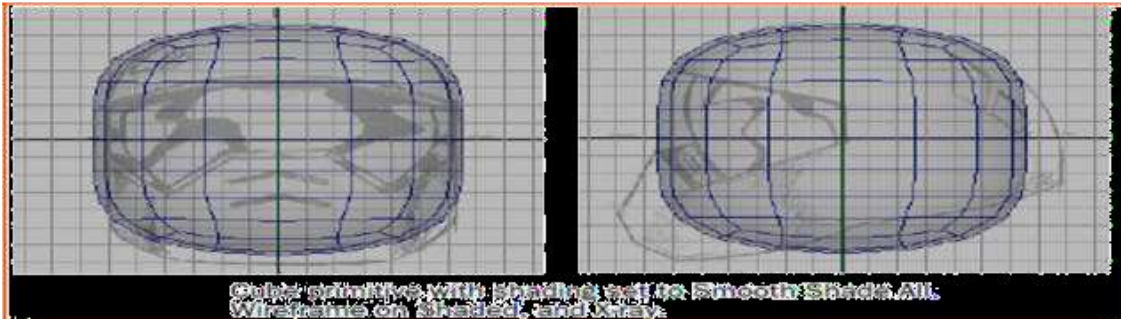

Fig.3.5.3: Wireframe

Model Symmetry

- Symmetry means taking advantage of object dimensions.
- In order to delete faces on left part of mesh
- In top view, mesh is right clicked & Face is selected from marking menu
- Bounding box is dragged around the faces in left side of helmet mesh in order to select it
- Delete is pressed and faces which have been selected are deleted

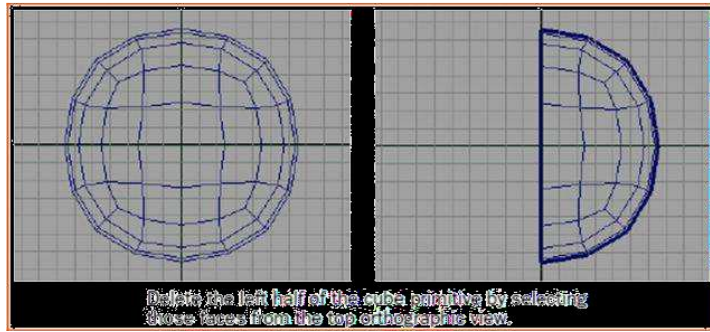

Fig.3.5.4: Model Symmetry

Demonstrate



Drawing a Polygon

Now we proceed to the front vision of Helmet that is the Protruding section of the front jaw.

Placing vertices for polygon

- In the side view go to Mesh, Create Polygon tool, in the Editor Enter the limit points to (6) after turning them on.
- Place this 6 points in the section of the front jaw that pushes out. Vertices to be places in anticlockwise direction.
- Close create polygon tool by pressing Q

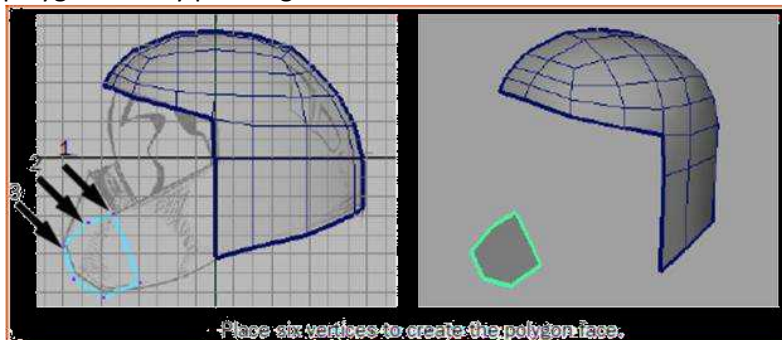

Fig.3.5.6: Creating Polygon face

Notes for Facilitation



- Summarize the main points.
- Ask participants if they have any doubts. Encourage them to ask questions.
- Answer their queries satisfactorily.
- Tell participants to complete the questions at the end of the unit.
- Ensure that every participant answer all the questions.

Unit 3.6: NURBS Modeling

Objectives

At the end of this unit, you will be able to:

- Apply 3D animation techniques on Maya Software-NURBS

Resources to be used

- Available objects such as black or white Board, chalk pieces or white board marker pens, duster.
- Pc with LCD Projector or Flip Chart.
- Participant Manual
- Copies of Handouts.

Do

- Greet and welcome the participants to the next unit of the program.
- Before starting the session ask them to do, they have any doubts pertaining to the previous unit.
- Acknowledge their responses and clear their doubts if any.
- Tell the participants they will learn about Nurbs.

Say

Tell participants about NURBS.

Elaborate

Non Uniform Rational Be Splines (NURBS) are surfaces that create smooth forms that calculatedly defines curves and surfaces which can be easily model and shaped specifically by using variety of techniques. NURBS surfaces are created using one or more NURBS curves that define the profile of the shape that you want for a surface, and then using a specific construction method to create the finished surface.

Maya has available Surfacing Tools that can create curve and surfaces for your profile by easy methodologies.

Demonstrate

Creating a Profile curve

Just like a potter's wheel Revolve is a technique to Model and create a Surface. You must first create a profile curve in an orthographic view and use the Revolve Tool to create a surface.

Creating a Revolve Curve

With the Revolve surface tool, a curve is rotated about an axis to create a surface. The user can define the axis of revolution.

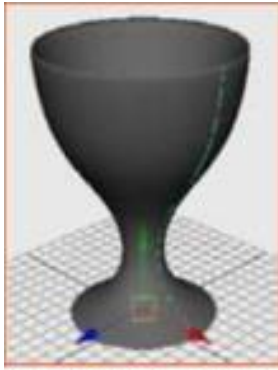

Fig.3.3.1: Creating a curve

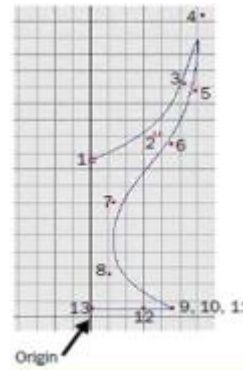

Fig.3.3.2: Creating a Profile curve

To create a revolve surface

- With the Created Curve in Selection Go to Surfaces, Revolve. Watch

this in Perspective view

Sculpturing a NURBS Surface

To prepare a sphere for sculpting

- Command Create, NURBS Primitives, Sphere in Reset Settings:
 - Radius: 6
 - Number of Sections: 30
 - Number of Spans: 30
- Always use Bigger Radius for comparison of size.
- Name the Object Egg
- Rotate Z axis at 90 Degrees and Set Scale X to get an Oval Shape.

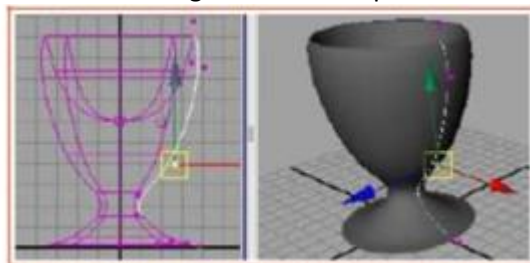
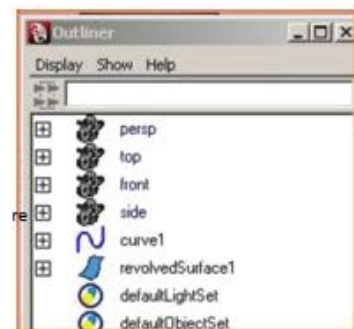

Fig:3.6.3: Creating a profile curve

Demonstrate



Demonstrate Basic Sculpting techniques to participants. Use various examples as:

Sculpting a Nose

Begin sculpting Egghead's face, starting with a simple nose.

To sculpt a nose for the character:

- In the Perspective view position the View Axis point towards you.
- Reset Sculpt Geometry Tool
- Keeping Radius One and opacity 0.2
- For Soft Edges click the Gaussian Brush
- At the middle of the Egg stroke downward from top to tip of an imaginary nose

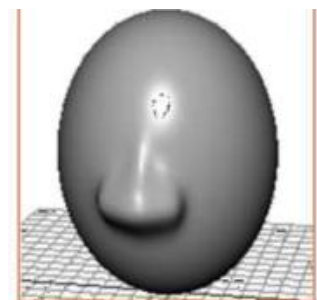

Fig.3.3.12: Sculpting a Nose

Demonstrate



Sculpt a Mouth following below mentioned steps

With the Original Sphere, Span and Section a delicate shape of the lips is difficult. that is why we will insert Isoparms

To insert additional Isoparms

- Select the Egg, Go to Tool box.
- Click Select Tools.
- Click Isoparms below the Nose.
- Holding Shift Key, click next to below so they Turn Yellow

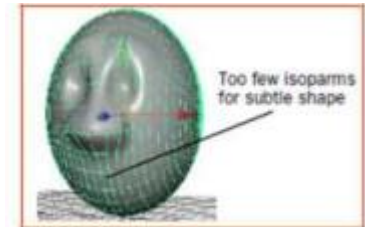

Fig.3.3.15: Sculpting Mouth



Fig.3.3.16: Additional Isoparms

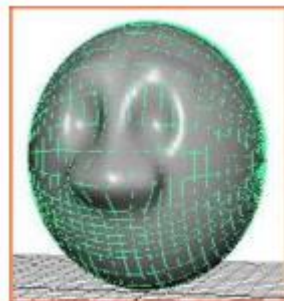
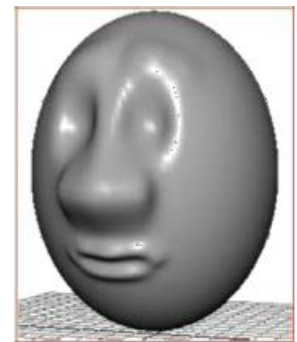

Fig.3.3.17: Insert isoparms

- Command Edit NURBS, Insert Isoparms.
- Turn On between Selections and Enter the Value 2 for Isoparms.
- Click On Insert
- This will give enough CV's for the delicate nature of Mouth

To sculpt a mouth for the character

- Go to Sculpt Geometry tool
- Select Push Option. Enter 0.2 Value for Radius and Keep reflection ON
- Start at the Centre below Nose Bridge for Lip Division and make a horizontal stroke
- Now use the Pull Operation.
- Setting Radius 0.3 and Draw Strokes for Upper and Lower Lip



Unit 3.7: Animation

Objectives

At the end of this unit, you will be able to:

- Use application of 3D animation techniques on Maya Software-Animation.

Resources to be used

- Available objects such as black or white Board, chalk pieces or white board marker pens, duster.
- Pc with LCD Projector or Flip Chart.
- Participant Manual
- Copies of Handouts.

Do

- Greet and welcome the participants to the next unit of the program.
- Before starting the session ask them to do, they have any doubts pertaining to the previous unit.
- Acknowledge their responses and clear their doubts if any.
- Tell the participants they will learn about Animation.

Say

Tell participants about animation.

Elaborate

A frame is the unit of calculation in Animation and techniques of scale, rotate, move are applied to it at set time to create illusion of motion. The scale is called frame per second. Setting different numerics to keys give the result of playback, Maya provides automatic calculation of attributes to play frames back in time to result in changing movements.

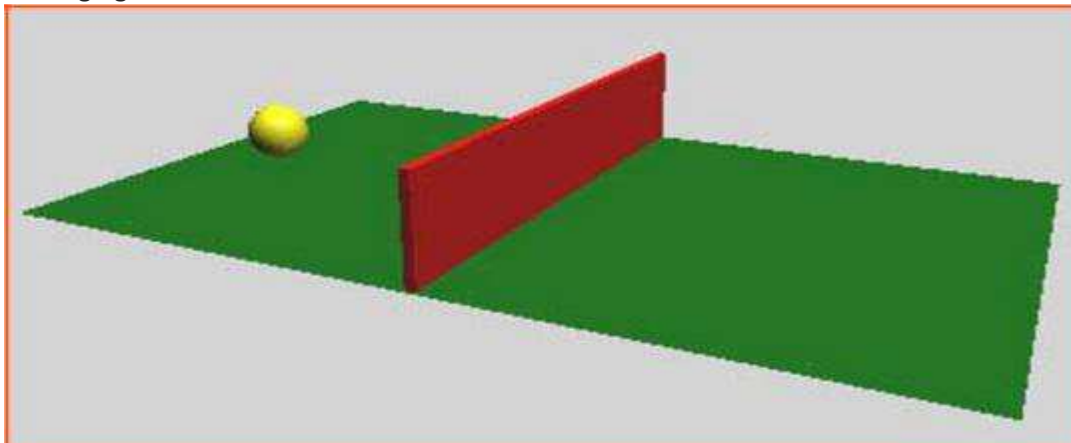

Setting the Playback Range

To open the scene

Make sure they've done the steps in "Preparing for the lessons" from the PH Open file name that is already saved on your interface that is named Key framing. MB in interface. This file can be found in the Getting Started Lesson Data directory that was installed with Maya Software, or from the drive where you copied the Getting Started Files.

Getting Started Lesson Data/Anim/Keyframing.mb

This scene has a Ball placed on Y axis near the Ground.

Setting the Playback range

To Animate this you have to set the position at different time ranges.

- Look over the playback controls, as shown in the Fig. below.

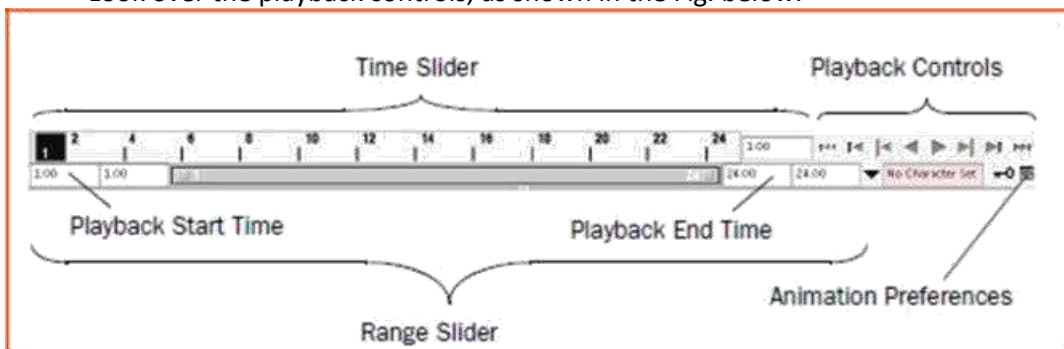

Fig.3.7.2: Playback Controls

Use Time and Range Slider. This slider helps you to control your animation with Specific time of Playback and Scroll. The Time Slider Keys are Red. There are buttons for Stop, Pause, Play and Rewind, Forward. The Playback Speed by the Animation preferences button. The Playback Controls control animation playback. You may recognize the conventional buttons for play and rewind (return to the start time). The stop button appears only when the animation is playing. To find out which operation a button represents, hold the mouse pointer over it. The Animation Preferences button displays a window for setting animation preference settings such as the playback speed.

The Range Slider controls the range of frames that play when you click the play button.

- In the playback End Time Box enters 72
- A frame rate of 24 frames per second (fps) is the frame rate used for motion picture film. For video, the frame rate can be 30 fps (NTSC) or 25 fps (PAL) depending on the format being used.
- with the range 1 to 72 you can create 3 sec of Animation. ($72 \text{ Frames} / 24 \text{ frames per Sec} = 3 \text{ sec}$. For a motion picture film 24 frames/sec used.

Demonstrate



Demonstrate how to set Keyframes, how to use graph editor and how to change timing of an attribute. Fine Tuning an Animation.

The following two Figure show examples of curves after modification. The two graphs are identical, except the curve points are selected in the second Fig. The second graph shows the position of the tangent handles.

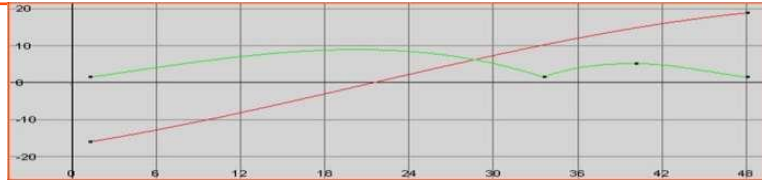

Fine Tuning an Animation

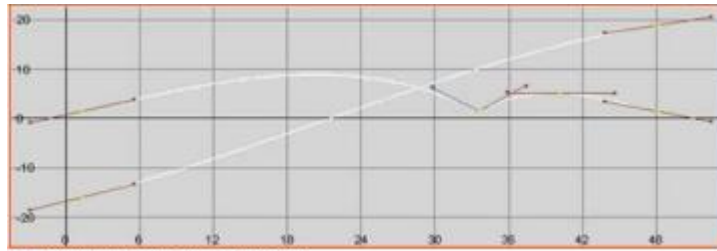

Fig.3.7.11 (b): Fine Tuning an Animation

Notes for Facilitation



- Summarize the main points.
- Ask participants if they have any doubts. Encourage them to ask questions.
- Answer their queries satisfactorily.
- Tell participants to complete the questions at the end of the unit.
- Ensure that every participant answer all the questions.

Notes



Skill India
कौशल भारत - कुशल भारत



सत्यमेव जयते
GOVERNMENT OF INDIA
MINISTRY OF SKILL DEVELOPMENT
& ENTREPRENEURSHIP



N S · D · C
National
Skill Development
Corporation

Transforming the skill landscape

4. Testing and other Terminologies

Unit 4.1 – Testing the model and quality assurance.

Key Learning Outcomes



At the end of this module, students will be able to:

- Examine traditional for orientation of two-dimensional figure face
- Check UVs for sleek texturing and shading
- Check the topology for sleek movement
- Demonstrate the steps to be followed to correct problems found within the model throughout the check

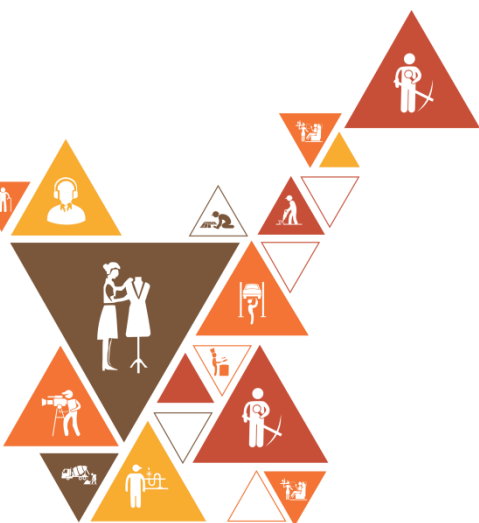

Unit 4.1 Testing the model and quality assurance

Objective

At the end of this unit, you will be able to:

- Examine the functionality of model prepared in line with story requirements.
- Test the generated models to ensure that they meet the production requirements and function
- Explain how to test a deliverable output.
- Explain the uses of UV mapping

Resources to be used

- Available objects such as black or white Board, chalk pieces or white board marker pens, duster
- PC with LCD Projector or Flip Chart
- Copies of handouts, Participants Handbook

Do

- Greet and welcome the participants to the next session of the program.
- Before starting the session ask them do they have any doubts pertaining to the previous unit.
- Capture their responses on board and share them wherever necessary.

Say

Tell the participants about Testing of a model.

Elaborate

Testing

Testing is a way of proofreading your work or checking if all functions as planned out. In animation it is a way on ensuring key areas are met during the process to understand if objectives are met. The team of designer, modeler and animator get together to test each stages of development of base and system.

Test planning process

In the testing period, requirements of both the production and function need to be checked, below are steps to ensure that.

- Step #1: Review and analyze the requirements
- Step #2: Scope of testing
- Step #3: Design the test strategy according to the scope
- Step #4: Identify the required tools needed for testing and management
- Step #5: Estimate the test effort and team
- Step #6: Define test schedule:
- Step #7: Enablement plan
- Step #8: Determine and procure the test environment
- Step #9: Identify test metrics
- Step #10: Create the model test plan, reviews and approved

Introduction to UV Mapping

UVs (pronounced U-VEEZ) are texture coordinates that define axes system and are along with vertex components of polygons and surface meshes. The space determines image placing and texture mapping on 3D surface and is called as UV texture space. UVs are markings that connect the surface texture and mesh with pixels and vertices.

Without UV coordinates rendering on surfaces or polygons cannot be done.

UVs and texture mapping

There is a difference between texture mapping of NURBS surfaces and Polygon and sub divisional surfaces. The texture coordinates (UVs) appear automatically and irregular on polygons, sub divisional surfaces as NURBS are rectangular or square that have specific UVs. Thus the control vertices are easily repositioned and textures comply with changes. With irregular coordinates they manually need to be modified to fit mapping of texture

UV mapping

It means creating specified UVs for two dimensional representation that can be created and edited on flat images to apply textures as it is proportional to the end image and application of texture in 3D surface mesh. It determines accuracy of textures on polygonal surfaces. Use UV texture editor to view and edit textures as many tools are provided to edit and manipulate textures, you can also set background to texture images for quick coordinates.

UV mapping tips

UV texture editor is the main tool that gives you various tools to create and edit your polygonal surfaces to create finest textures. Arranging your co-ordinates is a skill that needs to be acquired to apply different textures. Apart from creating textures you can fit an image by applying UVs.

Demonstrate



Snapping:

Lock your transformations using UV texture editor, even multiple UVs can be locked with the Preserve Component Spacing Option in the Move tool. The snapping function tool is relatable for this.



To snap to...	Hold	Icon
Grid intersections	x	 (In the Status Line)
Other UVs (points)	v	 (In the Status Line)
Pixels		 (In the UV Texture Editor toolbar)

Fig.4.1.1: snapping UVs



Skill India
कौशल भारत - कुशल भारत



सत्यमेव जयते
GOVERNMENT OF INDIA
MINISTRY OF SKILL DEVELOPMENT
& ENTREPRENEURSHIP



N S D C
National
Skill Development
Corporation

Transforming the skill landscape



Media & Entertainment Skills Council

5. Maintain Workplace Health & Safety

Unit 5.1 - Maintain Workplace Health & Safety

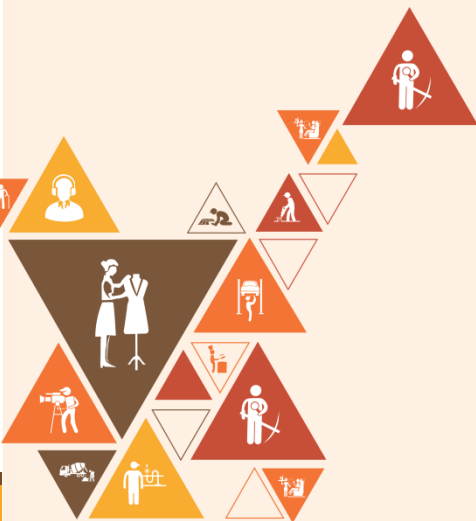

MES/N0104

Key Learning Outcomes

At the end of this module, students will be able to:

- Observing and understand the current health, safety, security policies and procedure of organization.
- Understand the safe working practices pertaining to own occupation.
- Understand the government rules and policies related to the health and safety including emergency procedures for accidents, illness, fires or others.
- Identifying the person responsible for health and safety in the working area, including those person whom to contact in emergency.
- Identifying the security signals in the workplace fire alarms, staircases, fire warden stations, first aid and medical rooms.
- Identifying the possible work hazards in the working area which can cause risk to others health and safety.
- Ensuring own and others health and safety in the workplace through precautionary measures.
- Identify and recommend the basic terms and opportunities to the designated person of your workplace for improving health, safety, and security.
- Identify and correct the cause of accidents, illness, and fires in your working area and within the limits of individual's authority.

Unit 5.1: Maintain Workplace Health and Safety

Unit Objectives



At the end of this unit, students will be able to:

- State some common reasons of accidents at site.
- State common accidents and prevention techniques
- State ways to stay healthy and hygienic (personal hygiene)
- Describe the common accidents that occur in studio.
- Describe the preventive measures to be taken to minimize accidents.
- Learn the procedure to use fire extinguisher
- Learn the ingredients of First-Aid Kit.
- Learn the methods of giving First-Aid in case of accident.

Notes for Facilitation



- Discuss the importance of safety at the workplace. Give some live examples if you have.
- Discuss what PPE (Personal Protective Equipment) is.
- Ask the students to discuss the important things to be taken care of while working in workshop.
- Ask the student what is the definition of health.
- Tell the correct definition of health and discuss its importance.

5.1.1: General Safety Rules

Say



- There are some safety rules which are common on every type of manufacturing work. Like, you should never drink liquor when you are on work.
- You should not ignore the safety rules as it may cause injury to you and your colleagues nearby.

Do



- Explain to the participants the importance safety rules.
- Divide the class into two groups and ask them to tell general safety rules one by one.
- If first group is not able to suggest safety rule then pass it to othe`r.
- Give points to the groups on each correct safety rule suggested for engraving studio.

Demonstrate



- Rearrange the desks in the classroom in random way so that there is very narrow passage to pass through them.
- Ask one student to run through the passage and ask the other student to run behind him to catch.
- Soon the student will get stuck in the passage or hit the desk. Tell the students if the things were arranged properly this should not have happened.

Steps: General Safety Rules



- Work intelligently.
- Keep studio space neat and orderly.
- Ensure appropriate ventilation.
- Have proper protective gear and cleaning supplies available.
- Wash hands and other exposed body parts after working, and before eating or using the bathroom.
- Maintain your health and fitness.

Summarize



- Summarize the general safety rules.

5.1.2: Health

Say



- There is a famous proverb “Health is Wealth” which means if a person is healthy he/she can do work and earn wealth.
- As defined by World Health Organization (WHO), Health is a "State of complete physical, mental, and social well-being, and not merely the absence of disease or infirmity."
- We should always stay healthy by mind, body and soul.

Explain



- Explain to the participants the importance of health.
- Explain the methods to stay mentally healthy.
- Explain the methods to stay physically healthy.
- Explain why it is important to be healthy by soul means having good thoughts for work as well as your colleagues.

Demonstrate



- Demonstrate the ill effects of bad habits on health via videos and encourage the students to quit bad habits if they have any.

Summarize



- Summarize the methods to stay healthy and fit.

5.1.3: Maintaining Personal Hygiene

Say



- Personal hygiene is a very important aspect of human which differentiate us from animals.
- Personal hygiene involves very basic things like taking bath regularly, brushing teeth etc.

Explain



- Explain the importance of maintaining personal hygiene.
- Explain how we can maintain personal hygiene.

Demonstrate



- Demonstrate the effect of not maintaining personal hygiene with the help of videos.

Summarize



- Summarize the methods to maintain personal hygiene.

5.1.4: What is an Accident?

Say



- An accident is a specific, unpredictable, unusual and unintended external action which occurs in a particular time and place, with no apparent and deliberate cause but with marked effects.

Explain



- Explain the types of accidents.

Demonstrate



- Demonstrate the common occurring accidents through videos or chart.

Summarize



- Summarize the types of accidents and measures to be taken to stop them.

5.1.5: What is a Fire Extinguisher?

Say



- Fire extinguishers are fire protection device used to extinguish or control small fires.

Explain



- Explain the types of fire extinguishers.
- Explain the use of different type of fire extinguishers.
- Explain the importance of proper pressure in the fire extinguisher and how to read pressure.

Demonstrate



- Demonstrate the types of fire extinguishers.
- Demonstrate the parts of fire extinguisher and use of each part.

Summarize



- Summarize the types of accidents and measures to be taken to stop them.

Activity



- Ask the students to assemble together.
- Explain the purpose and duration of the activity.
- Set guidelines pertaining to discipline and expected tasks.

Skill Practice	Time	Resources
Use of different type of Fire Extinguisher	6 hours	Fire Extinguisher, wood, plastic, electric supply and arrangement for short circuit, petrol to set mock fire

Do



- Ask the volunteer to come forward for using Fire Extinguisher.
- Ask the rest of students to keep a safe distance from the mock test area and watch very carefully.
- Go around and make sure the distance is safe.
- Handle different type of fire extinguishers to volunteers.
- Charge different type of mock fires in the open area and ask volunteers to extinguish the fire.

5.1.6: First Aid and First Aid Kit

Say



- First Aid is the assistance given to any person suffering a sudden illness or injury with care provided to preserve life, prevent the condition from worsening, or promote recovery.
- First-Aid Kit is an important part of tool kit. Accidents can occur anywhere so First Aid Kit should always be available in the toolbox.

Explain



- Explain the importance of First Aid Kit.
- Explain the methods of first aid in different situations.

Demonstrate



- Demonstrate the First Aid procedures in different situations.

Summarize



- Summarize the items in First Aid kit and the procedure to give first aid in different situations.

Role Play



- Ask the students to assemble together.
- Form the groups of 2-2 students.
- Ask one student in a group to provide first aid to other student in a given situation.
- Similarly, give different situations of first aid to each student.

Skill Practice	Time	Resources
Providing First Aid	8 hours	First Aid kit, notebook

Do



- Note down the performance of each group in providing first-aid.
- Once the role play is over, discuss the good and bad of students' performance.

5.1.7: Personal Protective Equipment (PPE)

Say



- Personal protective equipment (PPE) refers to protective clothing, helmets, goggles, or other garments or equipment designed to protect the wearer's body from injury or infection. The hazards addressed by protective equipment include physical, electrical, heat, chemicals, biohazards, and airborne particulate matter

Explain



- Explain the importance of PPE.

Demonstrate



- Demonstrate the components of personal protective equipment.



Skill India
कौशल भारत - कुशल भारत



सत्यमेव जयते
GOVERNMENT OF INDIA
MINISTRY OF SKILL DEVELOPMENT
& ENTREPRENEURSHIP



N · S · D · C
National
Skill Development
Corporation

Transforming the skill landscape



Media & Entertainment Skills Council

6. Soft Skills and Communication Skills

- Unit 6.1 - Introduction to the Soft Skills
- Unit 6.2 - Effective Communication
- Unit 6.3 - Grooming and Hygiene
- Unit 6.4 - Interpersonal Skill Development
- Unit 6.5 - Social Interaction
- Unit 6.6 - Group Interaction
- Unit 6.7 - Time Management
- Unit 6.8 - Resume Preparation
- Unit 6.9 - Interview Preparation

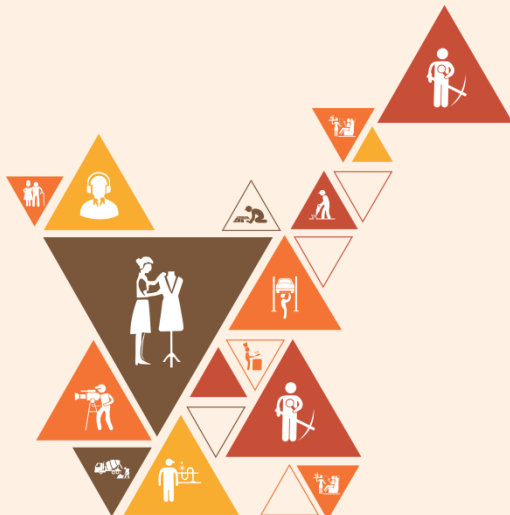

Key Learning Outcomes



At the end of this module, you will be able to:

- Discuss the art of Effective Communication.
- Practice effective Communication with co-workers and their Family.
- Analyse organizational behaviors in communication.
- Maintain health and hygiene
- Follows instruction
- Develop interpersonal skills
- Punctuality in work deliverable

Unit 6.1: Introduction to the Soft Skills

Objectives

At the end of the unit, students will be able to:

- Describe the basic meaning of Soft Skills, their components and their benefits.
- Familiarize with work readiness and its significance.

Resources to be used

- Available objects such as black or white Board, chalk pieces or white board marker pens, duster
- PC with LCD Projector or Flip Chart
- Participant Manual

Say

Employees are a crucial part of an organization, understanding them personally can be helpful in various aspects. There is much more to their identity than merely their skills. This brings into light, the concept of 'soft skills.

- Soft skills are personal attributes that describes an individual's ability to interact with others. It includes the cluster of personality traits, social graces, communication language, personal habits, friendliness and optimism that characterize relationship with other people.
- Soft skills have more to do with who we are than what we know.
- Soft Skills complement hard skills which are occupational requirements of a job and many other activities.
- According to a survey, the long-term success in job is 75 % due to soft skills and 25 % due to technical knowhow.

Activity

- Ask the students to form a circle.
- Starting from a one person, ask each of them to tell something about themselves. This should necessarily include their strengths and weaknesses.
- This will give them a better chance of knowing each other

Explain

Discuss what helps in keeping you happy in your school- academic knowledge or company of friends.

Say



Soft skills essentially relate to the personality of a person. There are certain components that relate a person to the rest of the group and on which communication depends largely. This largely ensures how a person gets along with other people:

- **Adaptability:** It is about how quickly and efficiently a person can blend in and get productive in an altered environment.
- **Emotional Strength:** An emotionally strong person succeeds in directing his moods and emotions such as anger frustration and excitement.
- **Leadership Quality:** How one manages conflict in personal and professional situation and convinces people reflects upon his leadership quality.
- **Team Playing Ability:** It is the ability to manage different types of people and make them work harmoniously with each other.
- **Decision Making:** This reflects upon how one manages his time and other resources in efficient and productive manner.
- **Interpersonal Communication:** This is an individual's ability to effective communication with other and in the process creating a positive image of him.
- **Negotiation Skills:** This is how one negotiates with others and reduces the level of stress in work, professional and personal environment.

Activity



- Ask students to sit in a circle.
- Blindfold a student and give him a packet of biscuit.
- Ask the other students to come one by one and ask for the packet and make attempt to convince him as to why he should be given the packet.
- The blindfolded person has the authority to refuse to give to the people who fail to convince him and give it only to the person who succeeds in convincing him.
- At the end of the game we would be able to have an insight as to which person possesses the best communication skills, negotiation skills, etc.

Explain

On the basis of the activity, discuss what corrective steps could the other people take to improve their communication/negotiation skills.

Say



A person who interacts well with others gets added advantages other than personal satisfaction. Also, personal traits like decision making, leadership ability are not only related to the concerned person himself but they affect others to whom the person interacts. Some of these benefits include:

- Increased credibility with customers
- Increased customer satisfaction
- More productive employees
- Recognition from the industry, employer and peers. In short, they aid in the personal growth of a person.

Activity



- Ask the students to sit separately.
- Ask them to write whether they buy grocery products from one shop daily or prefer to go to any shop selling such products.
- If they go to one shop, ask them to give reason for their loyalty. Is it the good behavior of the shopkeeper that keeps them loyal?
- Also, ask the people who do not have any such preference, reasons for this behavior.

Say



How do employees differ from each other? What makes an inexperienced person more successful than a previously working person? On being asked, the answer to this question could be right attitude. Merely performing a task is not the requirement. A person should do it with the right kind of attitude to get the best results. This can include:

- An enthusiastic attitude to the employer.
- A clear interest in the work being done.
- The ability to communicate appropriately in an adult working environment.
- The capacity to acknowledge customers and provide the assistance recommended by the employer.
- A commitment to maintaining their reliability and punctuality for the whole of the period spent in the workplace.

Activity



- Ask the students to form a group.
- Ask them about their interest- painting, dancing, etc. people might come up with different interests.
- Based on it, ask the entire group to do an activity say painting.
- Observation can show that people who like doing a particular task say painting are likely to show more zeal than others who do not have much interest in it.
- Also, such people are more likely to have an active participation throughout the activity and enjoy it rather than taking it as a burden.

Explain

Based on the results, discuss why some student's/ groups were able to get better results. This could be due to difference of interests, enthusiasm, confidence, etc.

UNIT 6.2: Effective Communication

Objective

At the end of the unit, students will be able to:

- Do public speaking.
- Describe his /her likes and dislikes for five minutes in the classroom.
- Basic etiquette during a conversation with another person, overcome shyness etc.

Resources to be used

- Available objects such as black or white Board, chalk pieces or white board marker pens, duster
- PC with LCD Projector or Flip Chart
- Participant Manual

Say

Communication is a tool that connects us with other human beings. An effective communication not only helps in developing a sense of belonging but also facilitates better working, improves relationships, reduces stress.

Say

- Communication is the process of exchange of words, ideas, feelings. It is the meaningful exchange of information between two or more participants.
- Communication requires a sender, a message, a medium and a recipient.
- Communication process is complete only when a receiver understands the sender message.

Elements of Communication:

Communication seems effortless but it essentially involves different stages in which information gets passed from the person who wants to share something with someone. These elements are as follows:

- Message: The speaker/communicator might want to share thoughts, feelings, information, etc.
- Encoding: For conveying a message, it has to be communicated using signs, symbols, words, etc.
- Decoding: He/ she tries to understand the meaning of the message as expected by the speaker.
- Understanding whether a message has been effectively conveyed and understood by the receiver can be done with the help of a feedback. It is a feedback that brings out the success or failure of a communication process.

Activity

- Call 2 students.
- Ask them to have a casual conversation.
- With respect to their conversation, explain who the speaker is, what is the message.
- Also explain encoding, decoding and feedback with respect to the conversation.

Explain

Discuss the importance of tone of voice, gestures, etc. in a communication process.

Say



Communication is not merely restricted to exchange of ideas and information verbally. In fact, it extends far beyond that. Even a newspaper is a mode of communication. It can be categorized into three basic types:

- Verbal Communication: It involves communication of ideas verbally.
- Written Communication: They include letters, books, newspapers are printed messages.
- Non-Verbal Communication: Their gestures to communicate a lot and aid them in conveying the meaning of the message or intensity.

Activity



- Ask 2 students to explain the process of communication.
- Pay attention to the way they explain.
- Categorize the various types of communication used by them.

Explain

Discuss the situations in which each of them is used.

Say



Communication may not always be carried on without hurdles. There might be many hurdles that might prevent from reaching the message to the receiver effectively.

The most common barrier known in communication is 'noise'. It not only creates a sense of irritation but may affect the intensity of effect of the message.

Apart from this, there are certain other barriers that affect communication/exchange of ideas between the sender and receiver.

Some of the barriers can be overcome- using simple language, active listening can be of great help.

Activity



Organize students into groups of 2.

- Give one of the students, an article about a totally unknown topic.
- Give him 10mins. Time to read it.
- Let him explain to the class by the end of the time, what the topic is all about and crucial details in it.
- Ask the students what they have understood.
- Discuss about problems in understanding (if any) faced by the rest of students.

On the basis of the activity above, discuss the barriers in communication. Also, discuss how these barriers can be taken care of.

Say



By now, we know that communication is a two-way process. It is not merely about the way a speaker communicates information but equally about how the receiver receives it. In verbal communication, most of the problems can be taken care of if the listener is listening actively.

An active listening involves all the attention on the receiver/listener's part to what the speaker is saying. It can not only help to deal with certain communication barriers but also help to avoid uneasy situations between the two and reduce chances of misunderstanding.

Activity



- Call 3 students.
- Give a student a written piece. Ask him to read it out loudly to the other 2 students.
- Provide one student with earphones to listen to music while listening to the information.
- Let the other person listen to it without any distraction.
- At the end of the reading, ask both the student to tell what has been read out.
- As a matter of fact we would find out that the person who has put all his attention in listening would yield better results in comparison to the other one.

Say



Most of the people are not good listeners. Not listening carefully can land a person into various unfavorable situations. However, this habit can be improved. Some tips are as follows:

- Concentrate what the person is talking about and not on noise or other external distractions.
- Understand his emotions and you get it all right. Is the speaker angry, happy or plainly inquisitive?
- When the speaker is saying or telling something, don't break the chain of his thoughts.
- Don't avoid completing sentences of the speaker. Let them speak and speak only after they finish.

Activity



- Ask the students to sit forming a circle.
- A student to start saying counting, the next one should follow saying the consecutive number.
- At the gap of multiples of 5, the respective student is expected to clap instead of saying the number.
- The student, who fails to do this, would be disqualified for the game. The others would proceed.
- At the end the one who wins the game would be considered the best listener.

Explain

Discuss with the students the importance of being an active speaker in a debate where counter-questioning is allowed.

Unit 6.3: Grooming and Hygiene

Objectives



At the end of the unit, students will be able to:

- Maintain cleanliness and hygiene.
- Keep their dress clean and tidy.
- Maintain positive body language while speaking.
- Enable to perform more of the do's than the don'ts.
- Leant about good eating habit and their impact on health.
- Avoiding bad things such as gutkha and alcohol.
- Learn about AIDS and its prevention.

Resources to be used



- Available objects such as black or white Board, chalk pieces or white board marker pens, duster
- PC with LCD Projector or Flip Chart
- Participant Manual

Say



The first impression that a person has on others is generally based on the way he/she looks. This doesn't include the physical beauty of a person but the way he carries himself.

Personal grooming not only makes us presentable to other people but good personal hygiene is essential for good health. Taking care of one's personal cleanliness - bathing, dressing according to the work environment, etc. form crucial part in creating impression about a person.

Every employee in an organization represents it in a certain way.

The personal appearance of each employee should be in accordance with the work environment.

Uniform/personal clothes should be neat and clean, ironed and well-buttoned.

Shoes should be well polished.

Emphasis should also be laid on having a decent hairstyle and neat nails.

Say



- Communication is the process of exchange of words, ideas, feelings. It is the meaningful exchange of information between two or more participants.
- Communication requires a sender, a message, a medium and a recipient.
- Communication process is complete only when a receiver understands the sender message.

Activity

- Show the students a chart having 2 girls- one dressed in a shabby way and another dressed decently.
- Ask the students which one they would prefer to be associated with in real life.
- Ask them to give reasons.

Explain

Discuss the importance of bathing daily, wearing neat clothes, etc. as they have learn from society. Also discuss whether one's appearance (in terms of clothes, cleanliness) affects the way people behave with them.

Say

There are certain norms as to how one should dress in a work arena. A decent appearance should be maintained.

This includes:

- Neat and ironed uniform
- A decent hairstyle should be adopted. Women with long hair should tie them.
- Nails should be neat, clean and well-trimmed.
- Flashy and noisy jewellery should be avoided.

Activity

Ask the students to write about why one's uniform should be neat, clean and ironed.

Explain

- Ask the students to discuss the importance of uniform in school.
- Also ask them to discuss about incidents when they formed an opinion about others based on their dress.

Say

The body posture of a person tells a lot about his personality. Also, the posture and gestures of a person convey about what is his attitude towards his work, display his seriousness, etc. Maintaining the right body posture generally involves the following dos and don'ts:

- Maintain straight & upright posture on the shop floor.
- Slouching on the floor, hands in pockets, hands on the hips are not courteous to the customer & hence should be avoided
- Apart from a good body posture, a person should »» Be on time
- Be courteous and attentive »» Be positive

Explain

Why are students advised to keep their hands at the back while talking to a teacher or while walking in a line?

Say



Body language plays a great role in conveying about a person. A positive body language is very important for conveying information positively. Certain do's and don'ts in this regard are as follows:

- Avoid your pockets. Keep your hands out of your pocket. Hand in pocket shows we are uncomfortable and unsure of ourselves. Keeping our hand in open indicates confidence and show that people has nothing to hide.
- Don't Fidget. Fidgeting is a clear sign of nervousness. An individual who can't keep still is an individual who is worried, tense and not confident. Keep your gesture calm and under control.
- Keep your eyes forward. This indicates that you are interested in communication with other. »» Stand up straight with your shoulders back. It communicates confidence
- Take wide steps. It makes you seem purposeful and suggest a personal tranquility and denotes confidence.
- Firm handshake. Grip other persons hand firmly and confidently instead of getting a palm full of dead fish. Firmness adds warmth and enthusiasm to the handshake. But make sure that you don't crush the other person's hand and don't hold on too long.
- Don't cross your arms when meeting other persons. Crossing your arms is a protective posture. Relax and keep your arms uncrossed.
- Use contact to show appreciation.

Activity



- Call 5-7 students. Ask them to enact different gestures like- one is told to stand up straight, other is told to enact the movements of shaky hands.
- Ask the rest of the class to judge the body language and the possible implications it could have on the viewer.

Explain

Why is so much attention laid at school level on making children stand straight?

Say

Personal Hygiene is the set of practices to follow to keep oneself healthy. Personal hygiene is directly related to the health of employees.

The following figure lists various activities that aid in keeping a person healthy.

Explain



- Why is maintaining personal hygiene considered important?
- If an employee doesn't maintain personal hygiene, can it have any effect on the people around him or the impression he makes on them?

Say



Physical fitness is very important for doing work effectively and efficiently. It can be maintained by different exercises like cycling, weight-lifting, jogging.

- It maintains optimal body weight.
- It reduces risk of diseases.
- It boosts confidence and self-esteem.
- It reduces stress, anxiety and depression
- If employees are free from such danger of diseases due to various factors like sitting for long hours, etc. They can stay fit and this will eventually help in increasing productivity.

Healthy Eating

Unhealthy eating habits can considerably affect the level of energy, concentration, etc.

For staying healthy, one should:

- Always try to eat home-made food
- Avoid oily food
- Always cook and eat fresh food
- Avoid junk food like burgers, carbonated drinks etc.
- Eat fruits regularly
- Drink lot of water

Alcoholism

Alcohol has the potential to damage almost every organ in the body including brain. Reduced work focus and drop in performance

Degradation in social and economic status

Withdrawal symptoms like anxiety, trembling, fatigue, headache and depression etc.

Tobacco

- Tobacco is the second largest cause of death in the world. It claims one death in every six seconds.
- Oral and spit tobacco increases the risk of oral cancer. It also causes mouth and throat cancer.
- It is the biggest reason for oral cancer which effects mouth, tongue, cheek, gums and lips
- Chewing tobacco lessens a person's sense of taste and ability to smell
- Smokers face a greater risk of suffering from lung cancer

Gutkha

Excessive use of gutkha can lead to loss of appetite; promote unusual sleeping pattern and loss of concentration along with other tobacco related problems. A gutkha user can be easily identified by prominently stained teeth ranging from dirty yellowish orange to reddish black. The stains are difficult to remove by normal brushing usually need the attention of dentist. According to a global adult tobacco survey 53.5% of Indians use tobacco products.

Each sachet contains 4000 chemicals, including 50 that cause cancer, Betel nut, Tobacco, Flavoring.

- Loss of sensation in tongue
- Disfigured mouth
- Increased sensitivity to heat, spices, cold and spices
- Inability to open the mouth
- Swelling, lumps, rough spots on gums or in other places inside the mouth
- Unexplained bleeding in mouth
- Difficulty in swallowing and finally Mouth Cancer

Activity



- Ask the students to make posters like- SAY NO TO SMOKING, etc. and ask them to wave them around the school.
- Also ask them to speak about the harmful effects of these bad habits on health.

Explain

How can smoking effect the productivity of a worker?

The intake of alcohol, cigarettes is increasing in India. What steps can be taken to handle minimize their use?

Say



AIDS stands for Acquired Immunodeficiency Syndrome. It is caused by HIV-human immunodeficiency virus. There is a general notion that it is caused merely by unprotected sexual relationships. However, it is not true. There are other ways of its transmission as well:

- Contaminated blood transfusion
- Hypodermic Needles
- From infected mother to child

As per studies in India HIV/AIDS is largely due to unsafe sex worker interactions. About 86 % HIV incidents in the country is from unprotected sex.

A survey has shown gender based difference. Out of the total population of 0.29% females are suffering from AIDS while in males it accounts to 0.43 %.

AIDS is not a disease like cancer or malaria, but is a condition that weakens a person's ability to fight diseases (immune system).

There are no medicines or vaccines for AIDS so far. The treatment and medicines which are available in the market are expensive and have side effects.

Organizations like national aids control organization (NACO) aims to make people aware about the causes and symptoms of AIDS and emphasize the importance of having protected sex.

Say No to AIDS

Even one visit to a sex worker may result in HIV infection. So it is advisable to avoid multiple sex-partners and always use protection (condoms/nirodh) during intercourse.

Use of Condom as a protection against it.

AIDS has no cure but can be prevented, therefore be cautious of it- not afraid of it.

Take blood only after checking proper medical certificates.

It is generally seen that people suffering from AIDS have to undergo not only physical pain but social alienation as well. It is important to know certain facts about the disease:

AIDS does NOT spread through

- Hugging
- Touching hands
- Mosquito bite
- Saliva or cough
- Taking care
- Sharing clothes
- Eating together or sharing utensils

Thus, AIDS does not spread so easily. HIV positive people should not be socially discriminated.

Activity

To judge the understanding of the students, randomly pick up any of them and ask about topics like symptoms of AIDS.

Explain

- Discuss with the students if they have known anybody suffering from aids and noticed any social discrimination experienced by that person.
- Discuss the importance of spreading awareness about AIDS.

UNIT 6.4: Interpersonal Skill Development

Objective

At the end of the unit, students will be able to:

- Develop a positive attitude and behavior.
- Practice Goal Setting.
- Motivated for team participation at work.
- Learn how to manage relations.
- Learn about Stress and anger management skills.
- Learn to develop leadership qualities.

Resources to be

- Available objects such as black or white Board, chalk pieces or white board marker pens, duster
- PC with LCD Projector or Flip Chart
- Participant Manual

Say

Interpersonal skill development is the blend of different traits of day to day life that play an important role in creating our impression in other's mind. It starts from inside. The role of interpersonal skill development is to help us understand how to make choices about our attitudes and actions.

One can learn to control over many aspects of our job and their environment by making appropriate choices and responses. These include various traits like:

- Positive Attitude
- Motivation
- Goal Setting
- Team Work
- Managing Relations
- Etiquette
- Stress and Anger Management
- Conflict Resolution

Activity

- Ask the students to organize themselves in groups of 10-12.
- Give them a time of around 30mins. And ask them to organize a 3mins. Play
- Ask them to solve all aspects related to the organization of the play themselves.
- After the end of the time duration, ask the teams to perform one by one.
- Assess their performance.

Explain

On the basis of the above activity, ask the students about the challenges faced by them in the process of preparation.

Try to point out what could be the possible reason behind the hurdle faced.

Say



The attitude of a person includes various aspects like- our approach, our outlook towards situations and others, the emotions we express towards others.

A positive attitude has the ability to deal with even the most difficult situations.

A positive attitude manifests in:

- Positive thinking
- Constructive things
- Creative thinking
- Optimism
- The motivation and energy to do things to accomplish goals
- An attitude of happiness Positivity not only affects a person to get the desired results in workplace but attracts people to his positive energy.

Activity



Make 5-7 slips stating a difficult situation, for instance- there is an annual event in the school. Due to some reason the tent house people could not manage to come there and carry out the tent and other decoration work. The event is just 1hr away. How would you manage the situation?

- After everybody has received a chit, give the students a time of 2-4mins. To think over the situation and write a possible solution.
- Collect the slips of the people who have got same situations. Compare them in terms of practical application, positivity, etc.
- Suggest other possible solutions.
- Applaud the students whose answers show the correct attitude and will to deal with the situation using their creativity.

Explain

An embroider who doesn't know how to carry out phulkari embroidery has been assigned the task of carrying it out due to labor shortage. Can he succeed in his work?

Explain

Explain the following story to the students to explain them better about positive attitude.

Raju works as a Supervisor in a factory. He is not happy with his job. One day he spoke about his dejection to his elderly friend, Prashant, who runs a small canteen for the factory workers.

"Prashant I am not satisfied with my job. There are so many problems in the factory. If I solve one, another one crops up. The problems seem to be never ending. I am quite fed up and wish to quit."

Prashant said nothing. He quietly put three pots with water on the stove. He put some carrots into one pot, some eggs into another and coffee beans into the third pot. The water in the pots began to boil.

Raju wondered what was going on! "Oh, here I am with my tale of woes, and this illiterate cook goes about his business!"

After some time, Prashant switched off the stove and put the carrots, eggs and the beans in different bowls. He then said, "My friend, what do you see here?" "Carrots, eggs and coffee", said Raju irritably. "Of course! Now come and feel them one by one", said Prashant. "Oh God! What do you want to prove?" asked Raju controlling his anger. "The carrots have turned soft. The egg is hard boiled beneath its shell and the coffee is stronger in aroma". "Exactly" said Prashant "Each of them faced the same degree of heat, but each reacted differently. The carrots that were so hard before became soft and weak. The egg was fragile with its thin outer shell, but after boiling it became hardened and the inner liquid portion became hard boiled. But the coffee beans are unique. After boiling in water, they became stronger and richer. So my friend, tell me, are you the carrot, the egg or the coffee bean? How do you respond to difficult situations? Are you like the carrot that is hard to look at but with the slightest difficulty becomes weak and soft? Are you the egg born with a soft heart but became tough and stiff after a difficult or a bitter experience? Or are you like the coffee bean that gets stronger and tougher and reaches its peak in extreme adversity or difficulty? When things get worse, you get better. "Thank you Prashant. You've opened my eyes. I shall strive and do my best."

Say



Give examples of various successful people like Rajnikanth, Dhirubai Ambani who had a humble background but succeeded in achieving their goals.

Goals provide a person a way of fulfilling his aspirations about ideal future. For achieving an overall career goal, it is important for a person to set up small terms goal. This not only helps in timely completion of work in the company where the employee is working but also aids in personal growth of the individual.

Goals should be SMART in nature.

S: Specific

M: Measurable

A: Attainment

R: Relevant

T: Time bound

Having goals is not just important in terms of an organization but it aids an individual more than an organization.

For an individual, goals render a helping hand for future because:

- Goals narrow attention and direct efforts to goal related activities.
- Goals lead to more effort.
- One works through setbacks if he is pursuing a goal.
- It develops and changes individual's behavior.

Categorization of Goals

A goal might not merely involve a professional aspiration. It can be for anything that a person wants to achieve in life. This may or may not be related to the professional arena.

- Career goals
- Financial goals
- Education goals
- Family goals
- Health goals
- Public Service

Activity



Ask the students to write about different types of goals in their life.

Explain

- Discuss about the importance of setting goals in life.
- Discuss the importance of setting up short-term goals.

Say



People working in an organization belong to different backgrounds, social setting, etc. They might be different in terms of their aspirations. However, within an organization, they have to join hands and work as one to achieve the organizational goals. In doing so, their personal goals take a back step.

Unity becomes the guiding way to achieve them.

A dynamic gets created between team members due to their dependence on each other for success.

Following aspects help in keeping the team spirit:

- Cooperation
- Trust worthiness
- Dependability
- Tolerance

For teamwork, the following things need to be kept in mind:

- A single person cannot achieve a big task single handedly.
- Big and difficult tasks can be accomplished only through collective effort, through teams.
- In a team, the team members stand by each other during good and bad times alike.
- Work together towards a common goal.
- Divide the task and share the burden.
- Help and accept help from others.

Activity



- Ask the students to divide themselves in groups of 7-8.
- Give each group the task of solving a series of riddles to reach the final destination that has different objects for different groups like needle for one, cloth for other and so on.
- While solving a riddle, the group members should not be standing with the other who is solving the riddle.
- In fact, the person who is solving it should give the clue obtained as an answer to the riddle and then the other should do the same. This would continue till the series of riddles is solved and the final object is reached.
- This gives a chance of teamwork, trustworthiness, etc. between the team members.

Explain

Discuss the importance of team dynamics in a badminton doubles match.

Say



Explain to the students the following story in order to make them understand the importance of coordination and teamwork without which an organization would not be able to work well.

Once there was a shoal of tiny red fish living in the sea. One among them was a little different. His name was Swimmy and he was black in colour. Swimmy was the fastest swimmer in the shoal. The fish would swim around in the sea looking for food. One day when they were busy searching for lunch, Swimmy who was far ahead of the others saw a big fish coming in their direction. The big fish was also looking for his lunch--- smaller fish. Swimmy was scared! If the big fish would spot his shoal, all of them would be eaten up.

Say



Swimmy thought hard of a way out and quickly came up with a plan. He quickly swam back to his shoal and told all the fish about the big fish and also explained his plan to escape from being eaten.

When the big fish came closer he was shocked to see an even bigger fish swimming in his direction with its huge jaws wide open. Frightened that he would get eaten up, the big fish swam away. If he had looked carefully, he would have realized that the huge fish was actually all the tiny red fish swimming very closely together in such a way that they looked like one big fish. And little black Swimmy, being different, became the eye of the 'huge' fish!

Since human beings are social beings, they cannot remain alone. They meet people around them and form relations with them. Talking to other people and developing relationships with them helps us to feel comfortable in a place.

Building relations and talking to people not only helps us to feel comfortable in a place but help in performing our job better. 70% of the workplace learning is informal, when people talk to each other at work they actually are learning to do their job better.

Also, friendlier workers are effective communicators, more productive and trusted more by employers and co-workers.

Tips for improving relations with people around us:

- Observe how you react to people such as do you reach to a conclusion before knowing all the facts.
- Introspect honestly about how you think and interact with other people.
- Look at the work environment and behave accordingly.
- Accept your weaknesses courageously and work on them.
- Take responsibility for your actions.
- If you hurt someone's feeling apologize directly.

Activity



- Give the students a topic to discuss.
- Ask them to discuss about all possible aspects in the topic-negative and positive.
- Ask 2 students having opposing opinions to come forward and have a healthy debate.
- At the end of it, ask them what they have learnt from each other.

Explain

- Ask from the students whether they have ever felt awkward on a day when their friend was absent.
- Discuss the possible implications.

Say



Different people have different personalities. Their basic nature, the way they respond to others, etc. may not be same. In fact, this is what makes them different from others. However, in an official and public setting, a person doing simply what he wants may be uncomfortable for others around him/her. This brings into light, the importance of etiquettes.

Etiquettes are the customs or rules governing behavior regarded as correct or acceptable in social and official life. Certain etiquettes that should be kept in mind are as follow:

Stand straight, make eye contact and turn towards people when they are speaking and genuinely smile at people.

Say

Follow the dress code prescribed by the organization.

- Limit personal calls especially when you are working in a manufacturing unit.
- Eat and smoke to the designated areas only otherwise it may disturb other people.
- Apart from certain etiquettes, certain ethics are also expected to be followed by the employees of an organization.
- Ethics are basic rules regarding how people of a particular profession/professional setting are supposed to work.

Certain work ethics include:

- Discipline
- Commitment to work
- Punctuality
- Ownership and responsibility
- Striving to excel

Activity

- Ask the students to narrate instances when they have been scolded by their school teachers/ elders for behaving inappropriately-like dragging one' feet while walking, etc.
- Look for other such instances.

Explain

To test what the students have understood, discuss with them various etiquettes that need to be taken care of in a school.

Say

In the modern era, our lives have got so busy that stress and anger have become common.

Anger is a normal and healthy emotion. However, managing anger can be a problem for some people.

There are many health issues related to a unresolved anger such as high blood pressure, heart attack, depression, anxiety, colds and flu and problems related with digestion.

Signs of anger include faster heartbeat, quick breathing, and tension in shoulder or clenching fists.

- Express your feelings instead of boiling them up.
- Accept the things you can't change.
- Learn to forgive.
- ANGER is only one letter away from DANGER.
- Anger can destroy lives, destroy relationships.

Do's

- Post pone for a few seconds whatever you wish to say or do.
- Take a deep breath.

Activity

Ask the students about situations when they realized that their stress/anger disabled them from performing their best.

Explain

Discuss the problem of increasing levels of stress and anger among the youth. Also discuss the ways to manage anger and stress.

6.4.8 Conflict Resolution

Say



A conflict is a situation that is difficult to understand, a problem between two people having opposing opinions, etc.

Conflicts can be managed if following things are kept in mind:

1. STOP . . . before you lose control of your temper and make the conflict worse.
2. SAY . . . what you feel is the problem. What is causing the disagreement? What do you want?
3. LISTEN . . . to the other person's ideas and feelings.
4. THINK . . . of solutions that will satisfy both of you.

Activity



- Call out a student randomly.
- Ask them to narrate an incident when they had a fight with their friend and it resulted in further problems in school, became a cause for mental stress.

Explain

Discuss the importance of resolving conflicts for a person's mental peace, maintaining order and healthy environment in workplace.

6.4.9 Leadership Skills

Say



A leader has to take care of all these responsibilities.

The ability to lead effectively is based on a number of key skills like:

- Honesty: A leader who is honest will arise a feeling of trust amongst other employees.
- Ability to delegate: Assigning who should do what depending on their strengths.
- Good communications skills: Being able to communicate clearly is quite important.
- Confidence: Keeps morale of the team high even in the tough times.
- Commitment: If you expect your team to work hard and produce quality content then you should lead by example.
- Positive Attitude: Keeping teams motivated towards continued success of the company.
- Creativity: During the critical situations it is important to think out of the box solutions than to prefer the set course of action.
- Be decisive: He should be able to decide between different alternatives available and handle conflicts.

Say

- Focus on the big picture: Planning long term strategies for your department helps in the accomplishment of organizational goals.
- For becoming a leader, a person needs to grab opportunities, think out-of-box, take initiative in solving problems, be innovative in approach and have good relations with others.

Activity

- Ask students to arrange themselves in group of 7-8.
- Assign each group the task of selling products of companies(enactment)
- Ask the group members to choose a leader.
- Ask the leader to coordinate different activities of his team members to create a collective campaign for the brand.
- Give them 20mins. Time for doing this.
- See the performance of different groups.
- Seeing the performance of each group, assess whether the leader has carried out his responsibilities well.
- Suggest changes, if necessary in the practices/ attitude of the leader.

Explain

Discuss the role of a team leader in terms of team's performance.

UNIT 6.5: Social Interaction

Objectives

At the end of the unit, students will be able to:

- Understand what social interaction is and what social interaction behaviors are.
- Give a brief description about himself/herself in public.
- Follow daily duties.
- Cooperate with peers, family and other members in society.

Resources to be used

- Available objects such as black or white Board, chalk pieces or white board marker pens, duster
- PC with LCD Projector or Flip Chart
- Participant Manual

Say

A person is judged good or bad from the way he behaves with other people.

Social interaction is the process by which we act and react to those around us.

Social interaction includes a large number of behaviors:

- Exchange
- Competition
- Cooperation
- Conflict
- Coercion

Activity

Explain to the larger group that in a moment they will be dividing into smaller groups according to some commonality. For example “Divide yourselves into groups according to your favorite season!” At this time, all the people who enjoy summer get into a group, and so on.

Once groups are formed, the facilitator points to each group and ask them to shout in unison what group they have formed. If another group has the same category, have the two groups merge and celebrate together.

After all groups have been identified, the facilitator shouts out another type of division.

This activity not only gives a chance to the students of knowing each other’s likes and dislikes but also facilitates traits like cooperation, coordination while having fun.

Explain

Discuss the difference between settings where people know each other well, are ready to cooperate and coordinate with a situation where people are not ready to resolve differences, etc.

6.5.2 Self- Introduction

Say

People tend to form an impression about us even before we have a conversation with them (based on our body language, gestures). However, the way we present ourselves in front of people is the real indicator of our personality. Self- introduction is an activity in which a person introduces himself (generally in front of strangers or people who don't know him much).

Points that should be included in self-introduction are:

- Wishes: A “good morning my dear friends” helps in capturing the attention of the listeners and maintains an immediate relation with the, -not an imposed one. It has to be done keeping in regard the time.
- Purpose: We have to tell the purpose of coming in front of the audience. We can say-“I have come here to tell you about myself”.
- Name: Here you tell about your name. To grab the attention of the audience, one has to present his/her name differently. This can be done but telling its meaning and connecting it with one's personality.
- Family and Location: Telling someone about one's family makes them feel trustworthy and also gives them a chance to understand the background to which he/she belongs.
- Profession: Tell what you have been doing till then/ at present.
- Life Aim and Achievements: This allows others to have a peep in what the person wants to do in his/her life and what he is doing to succeed.
- Strengths and Weaknesses: This renders a personal touch to the introduction.
- People you like and dislike: This could include one's role models, a type of people that one's hates say, dominant people.
- Telling about a turning point in your life will help in them to understand why you are the way you are at present.
- Improvement in one's self-introduction can be done by introspection which can include:
 - Listening to what you are saying to yourself
 - Monitoring your self-talk
 - Changing your introduction

Activity

- Randomly call out 3-4 students.
- Ask them to give an introduction of self.
- Suggest changes, if necessary in the way introduction has to be done/ information conveyed.

Explain

- Discuss the importance of a confident self-introduction.
- Also, discuss whether boasting about oneself while introducing is right.

6.5.3 Our Duties and Responsibilities

Say

Being the citizen of India, citizens not only have certain rights but certain duties as well. According to Indian constitution, a total of 11 duties exist. These duties include:

- To abide by the Constitution and respect its ideals and institutions, the National Flag and the National Anthem.
- To cherish and follow the noble ideals which inspired our national struggle for freedom. »» To uphold and protect the sovereignty, unity and integrity of India.
- To defend the country and render national service when called upon to do so
- To develop the scientific temper, humanism and the spirit of inquiry and reform.
- To safeguard public property and to abjure violence.
- Apart from constitutional duties, in a workplace, a person has certain duties and responsibilities as an employee as well. This may include- being honest to one's work, completing work on time, being respectful towards others, etc.

Activity

- Divide the students into groups of 7-8.
- Assign each group to come up with duties that are to be taken care of in different areas- say workplace, home, school, etc.

Explain

Discuss what would be the situation if people do not follow their respective duties and responsibilities in different areas.

6.5.4 Cooperation

Say

Imagine what be the situation when people work in their own way and do not care about the convenience of others.

Cooperation is the process of groups of people working or acting together for their mutual benefit.

It is the backbone of any society.

In a family setting, cooperation might involve planning together and sharing responsibilities.

Effective peer support can be in form of:

- **Social Support:** In form of positive psychological interactions with others with whom there is mutual trust and concern.
- **Experiential Knowledge:** contributes to solving problems and improving quality of life.
- **Emotional support:** Esteem, attachment and reassurance
- **Instrumental Support:** Material goods and services
- A person cannot merely expect others to be cooperative. For others to behave in a cooperative way with him, he needs to be cooperative with them too

Say

This might involve:

- Share when you have something that others would like to have.
- Take Turns when there is something that nobody wants to do, or when more than one person wants to do the same thing.
- Compromise when you have a serious conflict.
- Do your part the very best that you possibly can. This will inspire others to do the same.
- Show appreciation to people for what they contribute.
- Encourage people to do their best.
- Don't isolate or exclude anyone. Everybody has something valuable to offer, and nobody likes being left out.

Activity

- Ask the students to choose a partner for themselves.
- Now, give each team a task of carrying out different types of stitches on different types of clothes.
- Ask them to divide the work between themselves and carry it out within a time span of 20mins (One can fetch the materials needed from other room from time to time; other could carry out the task of doing the actual stitch).
- Assess the performance of students.

Explain

- Based on the above activity, discuss the problems faced while doing the task.
- Also discuss what could have been the possible solutions to it.

UNIT 6.6: Group Interaction

Objectives

At the end of the unit, students will be able to:

- Participate in group discussions in the class.
- Give speech in the public.
- Understand the importance of team building and teamwork.

Resources to be used

- Available objects such as black or white Board, chalk pieces or white board marker pens, duster
- PC with LCD Projector or Flip Chart
- Participant Manual

Say

For a successful and positive group interaction these steps needs to be followed:

- Put your mobile phone away or place in silent mode.
- Greet everyone.
- Be friendly with everyone in the group.
- Show an interest in others by paying someone a compliment and listen carefully to what is being discussed.
- Be proactive and introduce yourself to others in the group.
- Sit up straight. Poor body posture is an indication of low self-esteem.
- Focus your attention on the person talking.
- Consider everyone's comment. Remember everyone is different and have different the ability to think.
- Think before you speak. Don't be too quick to jump into the conversation.
- Be a respect listener and observer.
- Include everyone when talking. Be sure to share eye contact with each person in the group.
- Don't start or participate in a side conversation.
- Make sure to smile shake hands and embrace and use each person's name during discussion.

Activity

- Give the class a topic to have a healthy discussion, say Effects of Modernization on Environment.
- Encourage them to come up with different points and all possible aspects.
- Ask people to support or negate a point according to their perspective.

Explain

- Observe students during the activity.
- If you find any of the persons flouting norms of a group interaction, guide him accordingly.
- Also discuss how does not complying with norms affect the ongoing/effect of a group interaction.

Say



Group interaction not only serves the purpose of carrying out a task efficiently but also serves to be useful as:

- It helps to understand a subject more deeply.
- It improves the ability to think critically.
- It helps in solving a particular problem.
- It helps the group to make a particular decision.
- It gives the chance to hear other students' ideas.
- It increases your confidence in speaking.

As a moderator a group interaction helps in understanding ones attitude, selecting a perspective candidate in a perspective methodology.

Dos and Don'ts of Group Interaction

Fig.6.6.2: Dos and Don'ts of Group Interaction

Do's	Don't
<ul style="list-style-type: none"> • Speak pleasantly and politely to the group. • Respect the contribution of every speaker. • Remember that a discussion is not an argument. Learn to disagree politely. • Think about your contribution before you speak. How best can you answer the question/ contribute to the topic? • Try to stick to the discussion topic. Don't introduce irrelevant information • Agree with and acknowledge what you find interesting. 	<ul style="list-style-type: none"> • Lose your temper. A discussion is not an argument. • Shout. Use a moderate tone and medium pitch. • Use too many gestures when you speak. Gesture like finger pointing and table thumping can aggressive. • Dominate the discussion. Confident speakers should allow quieter students a chance to contribute. • Draw too much on personal experience or anecdote. Although some tutors encourage Students to reflect on their own experience, remember not to generalize too much. • Interrupt. Wait for a speaker to finish what they are saying before you speak

Activity



- Try games like telephone, where you sit in a circle and one person whispers a scenario into the ear of the next person, such as how an important report was not delivered to the president in time.
- The “telephone” chain continues until the last person, who announces what he or she heard. Generally, by the end of the chain the story has been altered substantially.
- This gives employees a chance to discuss how the story changed along the way and methods they could use in the future to improve communication.

Explain

Discuss the importance of interaction among your family members.

Say



A good team is the one that motivates its members to have a positive attitude, perform better. Team work is a very important part of working life. They can have a big impact on the profitability of an organization, team and individual performance, company reputation, etc.

Team building is important because:

- Facilitates better communication
- Motivates employees
- Promotes creativity
- Develops problem-solving skills
- Breaks the barrier

Maintaining a team is not an easy job since there are a variety of people involved having different strengths and weaknesses. This task can be made easier by following certain do’s and don’ts

- Don’t argue in public: If you have a disagreement with someone in the team find a neutral place to discuss the situation.
- Do encourage each other: When things get tough the tough gets going. Contribute to the team in trying situation.
- Don’t talk behind the backs: If you have trouble with some team member don’t share with others. Go directly to the person in a kind and compassionate manner and share what is in your mind.
- Do lend a hand: If a team members is asking for help don’t hesitate in helping him.

Activity



- Ask students to organize themselves in a team of 7-8.
- Assign them the task of giving a presentation on different types of stitches.

Explain

- On the basis of the activity, ask the students to judge who was the best team member.
- Discuss the qualities of this person so that other people can improve themselves and cooperate and be more effective in future.

Unit 6.7: Time Management

Objectives

At the end of the unit, students will be able to:

- Describe the importance of time management.
- Develop time management skills.
- Learn about effective time planning.

Resources to be used

- Available objects such as black or white Board, chalk pieces or white board marker pens, duster
- PC with LCD Projector or Flip Chart
- Participant Manual

Say

Time management is the act of process of planning and exercising conscious control over the amount of time spent on specific activities, especially to increase effectiveness, efficiency or productivity.

Activities that aid in time management are:

- Delegate tasks.
- Identify time wasters.
- Combine activities – Plan for them.
- Break down big tasks down to the smallest task possible. »» Accomplish them one by one.
- At the end of the day conduct a simple analysis to see which activity took time.

Activity

- Ask the students to assemble in groups of 9-10 in ground.
- Organize a race that is broken into various stages like lemon race, followed by one-leg race and balloon race.
- Ask the team members to decide among themselves who will do what.
- The team that would be able to complete the task within a time of 4mins/ at the earliest would be the winner.

Explain

On the basis of the activity, discuss the factors that caused the team members lag behind and which factors enabled them to carry it within the assigned time.

Relate it to the wider arena- that is to time management (when more than 1 person is involved) in general sense.

Say

Time robbers are those activities which create interruption at the workplace. These activities create a deviation from the objectives which needs to be achieved. Time Robbers could be:

- Poor personal planning and scheduling.
- Interruptions by people without appointments.
- Poor delegation.
- Poor use of the media: Telephone, Mobile, e-mail, and fax, etc.
- Reading junk mail.
- Lack of concern for good time management.
- Lack of clear priorities

However, time robbers are not inevitable. They can be kept in check. The Time Robbers can be avoided by:

- Being active all the time
- Developing and maintaining an organized personal activity schedule
- Setting priorities
- Proper delegation
- Utilizing modern technical media

Activity

Divide students into groups of 3-4.

Ask them to choose a fabric of their choice, cut it in a particular shape and perform any embroidery of their choice.

Give them a time limit of around 30mins.

Explain

- On the basis of the activity, discuss what factors caused delay in time (if any).
- Also discuss what can be done in future to avoid such wastage of time.

Say

Not only is the completion of task important, equally important is finishing it on time. A task that is not completed on time may lead to decline in goodwill, decrease in productivity and consequent losses, etc.

Urgent Important Matrix

1.The Urgent and Important Tasks	2. The Non Urgent but Important Tasks
DO NOW <ul style="list-style-type: none"> • Emergencies, complaints and crisis issues • Demands from superiors • Planned tasks or project work now due • Meetings with superiors/colleagues 	PLAN TO DO THEM <ul style="list-style-type: none"> • Planning, preparation • Scheduling • Designing, testing • Thinking, creating, modeling the data
3. The Non Important but Urgent Tasks	4. The Non Important and non-Urgent Tasks
REJECT AND EXPLAIN <ul style="list-style-type: none"> • Trivial requests from others • Apparent emergencies • Misunderstandings appearing in work • Pointless routines or activities • Communications 	RESIST AND CEASE <ul style="list-style-type: none"> • Comfort' activities, computer • Games, net surfing, excessive • Cigarette breaks • Chat, gossip, social • Reading irrelevant and useless material

- Based on this fig., importance can be assigned to activities and they can be carried out accordingly depending on their importance.

Activity



- Ask each student to name the activities he engages in after going back to home.
- Ask him to categorize them as 'most important', 'important' or 'least important'.
- Discuss the list.
- Compare answers of different students.

Explain

Discuss the importance of categorization of tasks in terms of time management.

UNIT 6.8: Resume Preparation

Objectives

At the end of the unit, students will be able to:

- Describe the different sections of a resume.
- Learn how to prepare a resume.

Resources to be used

- Available objects such as black or white Board, chalk pieces or white board marker pens, duster
- PC with LCD Projector or Flip Chart
- Participant Manual

Say

- It is a matter of fact that all people are not suitable for all types of jobs. Imagine all sorts of people (fit and unfit for that particular designation) applying for a particular job! What would be the condition of the interviewer if he/she would have to take the interview of all the applicants? He would be exhausted and irritated.
- To avoid this situation, a resume is needed. A resume is a self-advertisement that, when done properly shows how your skills, experience and achievements match the requirement of the job you want.
- It convinces the employer that you have what it takes to be a successful in the new career or position.

Remember that...

- Your resume is to get you an interview not a job
- Your resume will be screened by an employer for just 15-20 seconds. That's all the time your resume has to make an impact.
- Every point in your resume should be specific and must be supported by a number of factual information.
- Use action verbs in all your points. They catch attention immediately and make your sentences clear.
- Use bullets not paragraphs.
- Do not mention your responsibilities mention what you have accomplished.
- A common mistake we make while constructing the resume is to copy the format from our friends resume and built it based on that.

Say

It includes basic details that are used to identify/contact a person in case he has to be called for the interview.

- Do not include your photo.
- Do not write your resume as a heading to the file
- Do not occupy much space to fill insignificant information like marital status, etc.

Say

It includes basic details that are used to identify/contact a person in case he has to be called for the interview.

- The objective of every job is different although eventually to reach the overall objective of the company.
- It is crucial to convey to your employer what your goal is. It should be aimed towards getting a particular position in a specific industry.
- Your objective should include the following:
 - Position wanted
 - Functional area
- Keep the employers requirement in mind while writing the objective. The objective is not what you desire from the company, it's about company's need.
- Be specific and restrict it to minimum words.
- One's objective should be different to each role one applies to.

Say

The educational qualifications of a person matter a great degree to the nature of work for which a person is required. For instance, for the field of engineering certain subjects and specialization would be required.

- Write all educational qualifications from class 10 till present.
- For class 10 and 12 – include school/college name, Board, Stream/Specialization (If any), year study, Marks.
- For undergraduate – include college name, University name, Degree and Specialization, year of study.
- Write all your qualifications in reverse chronological order, i.e. the latest qualification on top.
- You may write the educational qualifications in a tabular format or in a simple one after the other order.

Say

What will give insight to the employer about your achievements, interests? The projects, internships one has undertaken reflect a great deal about the person's interests.

- This is a critical component of resume, as it reflects the initiatives one has taken apart from curriculum.
- It not only reflects one's real potential but helps in differentiating one's resume from peers.
- The heading should be – title / project name, role, company/organization name, -2 lines description about the specific time period.
- Time period is must.
- The entries under each heading must be in reverse chronological order
- Be very specific on what you have accomplished. Add numbers and facts wherever possible.

Say

All the jobs might not pay much important to educational qualifications and internships. After all there are skills required to carry on a particular job that are required in a practical setting.

- List your skill and add a point which supports your skill the best.
- Make specific points. Add numbers and facts wherever possible.
- Pick only three to four soft skills that describes you the best.
- Dig your past to discover the best of these skills you possess and the best instance you can quote to support it.

One can have multiple headings under skills. Common heading can include:

- Soft Skills: Must include, they showcase your personality traits.
- Core occupational skills: Optional include if you possess any core skills. These are skills you possess relevant to the role you are applying for.
- IT Skills: Optional, Advisable to include this if you are applying for IT/software related roles.

Say



One's interests tell a great deal about the way a person is. They might also aid in some way in revealing the basic nature of a person. While writing about one's interests, one should keep in mind to:

- List interests which are meaningful and display some learning.
- Support the interest you have listed
- Make points specific and add supporting fact to it.
- Do not just list random cluster of interests like: adventure, guitar, reading, environment
- Never include interests like partying, watching movies etc. they create wrong impression.

Say



- Before selecting a candidate, an employer would like to know about the candidate's previous professional dedication. This might aid/ be negative immensely because it is this behavior that the person would exhibit in the work arena. Skills, etc. can be acquired through training but an employee should be hard working, trustworthy, responsible, etc.
- The proof of all this can be best obtained from previous employers, teachers, etc.
- The last thing on your resume should be a list of 2-4 professional references.
- Include the name of the reference, their relationship to you, mailing address, e mail and phone number.
- The place where one is applying may contact these people, so one should always call them in advance to let them know that you are using them for a reference and are currently applying for a job.

Say



Since resume is the first thing that would make an impression in front of the employer, one should make sure that it is professional enough in appearance. For ensuring this, certain things should be kept in mind: Make sure that the length of your resume does not exceed 2 pages.

- Do a thorough recheck and make sure there are absolutely no errors in your resume. No grammatical errors, no spelling mistakes, no punctuation errors.
- Run through your resume time and again for to make improvements and wording sentences better.
- Choose a professional font in a size 11 or 12. You can use multiple fonts for different parts of resume, but try to limit it maximum of two fonts. Instead of changing between fonts, try making specific sections bold or italicized instead.
- The font size of your header and the introduction to a section may be a size 14 or 16.
- Your text should always be printed in solid black ink. Make sure to deactivate any hyperlinks so that they don't print in blue or other contrasting color.
- Your page should have one inch margin all the way around with 1.5 or 2 point line spacing. The body of your resume should align left and your header should be centered at the top of the page.

Activity



- Ask the students to prepare their resume.
- Guide them, if necessary.

Explain

- Discuss with the students the type of language and font that should be used in a resume.
- Also, discuss why a long resume should be avoided.

Summarize

Give the students a summary of do's and don'ts while making a resume.

UNIT 6.9: Interview Preparation

Objectives

At the end of the unit, students will be able to:

- Understand the procedure of interview.
- Go through mock interviews.
- Understand how to present themselves during an interview.
- Motivated to work after the training period is over.

Resources to be used

- Available objects such as black or white Board, chalk pieces or white board marker pens, duster
- PC with LCD Projector or Flip Chart
- Participant Manual

Say

- Once the recruiter finds an applicant's resume in par with the requirements, he is called for an interview to know about him in person. Also, it helps to know about the personality traits of a person- confidence, patience, etc.
- An interview is a conversation between two or more people (the interviewer(s) and the interviewee) where questions are asked by the interviewer to obtain information from the interviewee.

Common Types of Interview

- **Traditional HR Interview:** Most interviews are face to face.
- **Panel Interview:** In this situation, there is more than one interviewer.
- **Technical interview:** Majority of the questions will be based on the skills sets mentioned in the candidate's resume.
- **Telephone Interview:** Telephone interviews may also be used as a preliminary interview for candidates who live far away from the job site.
An interview could be a nightmare and may not fetch favorable results if the interviewee is not well acquainted to the
- **Company-** What does it do basically and what are its goals.
- **Job description-** A person should have an idea about the job role he is applying to. He can answer to the questions of the interviewer accordingly.

Apart from knowing about the company and job role, a person should know about himself. He should not be afraid otherwise he would not be able to bring out his best. He should be free from all sorts of doubts about himself/herself and be

- Confident
- Relaxed
- Sure of yourself
- Prepared
- Before, during and after the interview, it is important for you to be prepared.
- Dress Professionally
- Choose your words properly
- Maintain an eye contact

To have a good impression and convey one’s level of seriousness, formal attire, minimalistic jewellery and clean and simple shoes are advised.

Say 

- Certain etiquettes need to take care of while giving an interview. This is because they are responsible for forming a favorable/unfavorable impression on the interviewer.

Activity 

- Ask the students to answer. Discuss why each of the activity falls in a ‘do’ or ‘don’t’ category.

Sentence	Do’s	Don’t
Be yourself		
Burp while talking!!!		
Just out from a ‘powder factory’ (worn too much make-up)		
Reach just about the right time for the interview		
Just barge in the cabin/ office		
Forget to greet the receptionist/ don’t respond		
Think before you speak		
Do your homework- Visit the company website		
Take time to think (TTTT)		
Wear bright color clothes on the D-day		
Emphasis on your strengths		
Argue/ Debate with the interviewer		
Chew gum during the interview.		
Review your educational and work experiences		
See your documents flying out of the file (Being clumsy)		
Thank the interviewer		
Have the ‘they need me’ attitude		
Maintain eye contact and good body language		
Only give monosyllabic answers(depends on the kind of questions asked...in-between)		
Carry a copy of your resume		

Explain

- Discuss with the students whether telling lies about oneself during the interview is right or wrong.

Say

- Apart from the content of one's answers (choice of one's words, etc.), the tone at which one presents himself is of considerable importance.
- Also, one should be fully aware about what he has written in the resume and have proper reasons for writing it and should not write anything shallow.

While, undergoing an interview, following things should be kept in mind:

- Be confident, not arrogant
- Sell yourself - Keep your energy up
- Maintain your posture
- Be positive, don't complain

Activity

- While conducting mock interviews in pairs, notice the body language, tone, etc. of students minutely.
- Give suggestions, if necessary.

Explain

- Discuss the importance of maintaining an eye contact with the interviewer.

Say

- While undergoing an interview, it is really important that the interviewee employees his full attention to the questions posed by the interviewer.
- If his mind gets diverted, he would not be able to answer appropriately.
- Also, in terms of selection, this could act as a big hurdle.

Activity

- Read out a passage to students.
- While reading, intentionally mispronounce certain words.
- Ask the students to stop you as soon as you mispronounce a word.
- Ask the students to carry it among themselves whenever they get free time.
- This would aid a great deal in knowing and developing their active listening skills

Explain

- Discuss the importance of active listening on the part of students when a teacher is explaining a topic.



Skill India
कौशल भारत - कुशल भारत



सत्यमेव जयते
GOVERNMENT OF INDIA
MINISTRY OF SKILL DEVELOPMENT
& ENTREPRENEURSHIP



N · S · D · C
National
Skill Development
Corporation

Transforming the skill landscape



Media & Entertainment Skills Council

7. IT Skills

- Unit 7.1 - Introduction to Computer
- Unit 7.2 - Basic Computer Knowledge
- Unit 7.3 - Components of Computer
- Unit 7.4 - Concept of Operating System
- Unit 7.5 - MS Word
- Unit 7.6 - MS Power Point
- Unit 7.7 - MS Excel
- Unit 7.8 - Internet Concepts

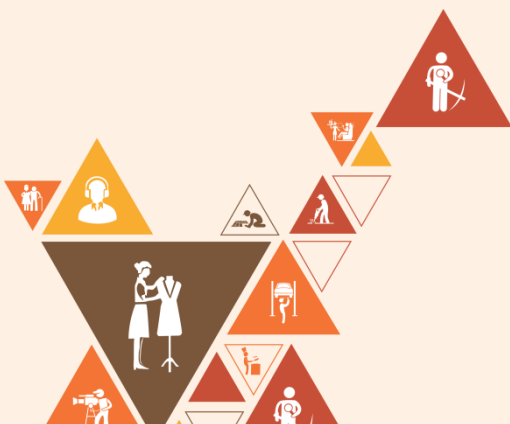

Key Learning Outcomes



At the end of this module, you will be able to:

- Discuss computers system
- Identify and use basic uses of a computer
- Analyse basic component of computer like CPU, motherboard etc.
- Describe computer operating system
- Use basic application like Microsoft Word, Excel and PowerPoint etc.
- Uses of Internet and communication through e-mails

Unit 7.1: Introduction to Computer

Objectives

At the end of the unit, students will be able to:

- Define the computer.
- Recognize its various parts.
- Differentiate the advantages and disadvantages of computer.

Resources to be used

- Participant Manual
- Computer Lab

Do

- Greet and welcome the participants to the next session of the program.
- Before starting the session ask them do they have any doubts pertaining to the previous unit.
- Acknowledge their responses and clear their doubts if any.
- Tell them they will learn about introduction to computer in this unit.

Say

- Tell participants about the computer. Computer plays a very important role in our personal and professional lives. It has become an integral part of our lives.
- Tell them about important characteristics and application of a computer.

Notes for Facilitation

- Summarize the main points of the unit.
- Ask participants if they have any doubts. Encourage them to ask questions.
- Answer their queries satisfactorily.
- Ask them to answer the questions at the end of unit given in the participant's manual.
- Ensure that every participant answer all questions.

Activity

- Tell participants to demonstrate the parts of computer.
- Give them 15 minutes to prepare.
- Tell them each participant will be given 10 minute to demonstrate the same.
- Once presentations are complete appreciate the efforts made by the group and summaries the highlights of the activity.

Skill Practice	Time	Resources
1. Demonstration of Computer.	4Hours	<ul style="list-style-type: none">• Participant Manual• Computer Lab

Unit 7.2: Basic Computer Knowledge

Objectives

At the end of the unit, students will be able to:

- Use computer.
- Explain the web, email services.

Resources to be used

- Participant Manual
- Computer Lab

Do

- Greet and welcome the participants to the next session of the program.
- Before starting the session ask them do they have any doubts pertaining to the previous unit.
- Acknowledge their responses and clear their doubts if any.
- Tell them they will learn about basic computer knowledge in this unit.

Say

- Tell participants about the application of the computer in daily life. In the workplace, many people use computers to keep records, analyze data, do research, and manage projects. At home, you can use computers to find information, store pictures and music, track finances, play games, and communicate with others— and those are just a few of the possibilities. Tell them about important characteristics and application of a computer.
- Now explain the concept of web. The World Wide Web is a gigantic storehouse of information. The web is the most popular part of the Internet, partly because it displays most information in a visually appealing format.
- Tell them about the application part of the web and introduce them with the use of different applications as email, instant messaging, picture music and movies with them.

Notes for Facilitation

- Summarize the main points of the unit.
- Ask participants if they have any doubts. Encourage them to ask questions.
- Answer their queries satisfactorily.
- Ask them to answer the questions at the end of unit given in the participant's manual.
- Ensure that every participant answer all questions.

Activity



- Tell participants to demonstrate the motherboard.
- Tell them they will get 30 minutes to prepare and each student will have to demonstrate for same.
- Once presentations are complete appreciate the efforts made by the group and summarize the highlights of the activity.

Skill Practice	Time	Resources
1. Demonstration of Motherboard	4 Hours	<ul style="list-style-type: none">• Participant Manual• Computer Lab

Unit 7.3: Components of Computer

Objectives

At the end of the unit, students will be able to:

- Recognize the different parts and components of computer.
- Describe the CPU, RAM and BIOS.

Resources to be used

- Participant Manual
- Personal Protective Equipment (PPE)

Do

- Greet and welcome the participants to the next session of the program.
- Before starting the session ask them do they have any doubts pertaining to the previous unit.
- Acknowledge their responses and clear their doubts if any.
- Tell them they will learn about the components of the computer in this unit.

Say

- Tell them about different parts of the computer.
- Explain-them about different parts of motherboard in detail.

Notes for Facilitation

- Summarize the main points of the unit.
- Ask participants if they have any doubts. Encourage them to ask questions.
- Answer their queries satisfactorily.
- Ask them to answer the questions at the end of unit given in the participant's manual.
- Ensure that every participant answer all questions.

Activity

- Tell participants to demonstrate the motherboard.
- Tell them they will get 30 minutes to prepare and each student will has to demonstrate for same.
- Once presentations are complete appreciate the efforts made by the group and summarize the highlights of the activity.

Skill Practice	Time	Resources
1. Demonstration of Motherboard	4 Hours	<ul style="list-style-type: none">• Participant Manual• Computer Lab

Unit 7.4: Concept of Operating System

Objectives



At the end of the unit, students will be able to:

- Familiarize with the concept of operating system.
- Work on Windows 8 and 9.1.
- Add or Remove desktop icons, make or delete a folder etc.

Resources to be used



- Participant Manual
- Computer System

Do



- Greet and welcome the participants to the next session of the program.
- Before starting the session ask them do they have any doubts pertaining to the previous unit.
- Acknowledge their responses and clear their doubts if any.
- Tell them they will learn about operating system in this unit.

Say



- Tell them about windows XP. And explain that Windows XP let you use different types of applications or software on the operating system.
- Familiarize them with the different versions of Windows.

Demonstrate

- Explain tools and parts of an operating system with the participants.
- Show them all these parts practically on the computer system.
- Then explain add or delete desktop shortcut from the desktop.
- Also explain how to create a new folder.
- Tell all participants to create a folder on computer.
- Then explain how to work on multiple windows.
- Now demonstrate the keyboard to the participants and tell them the correct way to use the keyboard.

Elaborate



- Discuss common window commands with the participants.
- Explain the table to the participants.

Table: Common Window Commands

Key	Description
Alt + E	Edit options in current program
Alt + Tab	Switch between open programs
F1	Universal Help in almost every Windows program
F2	Rename a selected file
F5	Refresh the current program window
Ctrl + N	Create a new, blank document in some software programs
Ctrl + O	Open a file in current software program
Ctrl + A	Select all text
Ctrl + B	Change selected text to be Bold
Ctrl + I	Change selected text to be in Italics
Ctrl + U	Change selected text to be Underlined
Ctrl + F	Open find window for current document or window
Ctrl + S	Save current document file
Ctrl + X	Cut selected item
Shift + Del	Cut selected item
Ctrl + C	Copy selected item
Ctrl + Ins	Copy selected item
Ctrl + V	Paste
Shift + Ins	Paste
Ctrl + K	Insert hyperlink for selected text
Ctrl + P	Print the current page or document
Home	Goes to beginning of current line
Ctrl + Home	Goes to beginning of document
End	Goes to end of current line
Ctrl + End	Goes to end of document
Shift + Home	Highlights from current position to beginning of line

Shift + End	Highlights from current position to end of line
Ctrl + Left arrow	Moves one word to the left at a time
Ctrl + Esc	Opens the START menu
Ctrl + Shift + Esc	Opens Windows Task Manager
Alt + F4	Close the currently active program
Alt + Enter	Open the Properties for the selected item (file, folder, shortcut, etc.)

Fig.7.4.1: Some Important Keys and Their Uses

Notes for Facilitation



- Summarize the main points of the unit.
- Ask participants if they have any doubts. Encourage them to ask questions.
- Answer their queries satisfactorily.
- Ask them to answer the questions at the end of unit given in the participant's manual.
- Ensure that every participant answer all questions.

Activity



- Give one newspaper cutting to each student and tell them they need to type the same.
- Tell them they have to use correct fingers on key board and make sure work is free from errors.
- Give them one hour for typing practice and ensure that each participant is typing.
- Finally share some tips for correct typing and summarize the highlights of the activity.

Skill Practice	Time	Resources
1. Typing Practice	2 Hours	<ul style="list-style-type: none"> ● News paper ● Computer Systems

Unit 7.5: MS Word

Objectives

At the end of the unit, students will be able to:

- Learn the concept of and practice MS-Word.
- Format a document.
- Print a document etc.

Resources to be used

- Participant Manual
- Computer System with MS Word

Do

- Greet and welcome the participants to the next session of the program.
- Before starting the session ask them do they have any doubts pertaining to the previous unit.
- Acknowledge their responses and clear their doubts if any.
- Tell them they will learn about MS Word in this unit.

Say

- Tell them about concept of word processing. Word processing skills allow us to prepare text documents such as letters, memos, and other correspondence.

Demonstrate

- Tell them to open MS Word in their respective systems.
 - Show them how to create a word document in MS word software.
- Practically demonstrate how to perform different operations on MS Word document as:
- Saving a Document
 - Change Font Type and Size
 - Create Headers and Footers by Inserting Texts
 - Indents and Spacing
 - Modifying Margins
 - Lists
 - Bulleted and Numbered Lists
 - Formatting Lists
 - Spelling and Grammar
 - Word Count
 - Different Editing Modes in Word
 - Inserting an Image and Table

Notes for Facilitation



- Summarize the main points of the unit.
- Ask participants if they have any doubts. Encourage them to ask questions.
- Answer their queries satisfactorily.
- Ask them to answer the questions at the end of unit given in the participant's manual.
- Ensure that every participant answer all questions.

Activity



- Give one news paper cutting to each student and tell them they need to type this in MS Word and perform different operations like saving documents, Saving a Document, Change Font Type and Size, Create Headers and Footers by Inserting Texts, Indents and Spacing
- Tell them they have to use correct fingers on key board and make sure work is free from errors.
- Give them one hour for typing practice and ensure that each participant is typing.
- Finally share some tips for correct typing and summarize the highlights of the activity

Skill Practice	Time	Resources
1. Typing and Formatting – MS Word	3 Hours	<ul style="list-style-type: none"> • News paper • Computer Systems

Unit 7.6: MS PowerPoint

Objectives

At the end of the unit, students will be able to:

- Practice MS-PowerPoint.
- Make a new presentation.
- Format a slide as well

Resources to be used

- Participant Manual
- Computer System with MS Office

Do

- Greet and welcome the participants to the next session of the program.
- Before starting the session ask them do they have any doubts pertaining to the previous unit.
- Acknowledge their responses and clear their doubts if any.
- Tell them they will learn about MS Word in this unit.

Say

- Tell them about the power point. PowerPoint is the presentation graphics software in the Microsoft Office suite. PowerPoint has predefined layouts, themes, and templates to create dynamic and professional presentations.

Demonstrate

- Tell them to open MS power-point in their respective systems.
- Show them how to create a power point in MS Power-point software.

Practically demonstrate how to perform different operations on MS Power-point presentation as:

- Saving a PowerPoint
- Working with slides
- View tabs
- Animating text and Images
- Removing Animations
- Working with Charts

Notes for Facilitation

- Ask participants if they have any doubts. Encourage them to ask questions.
- Answer their queries satisfactorily.

- Ask them to answer the questions at the end of unit given in the participant's manual.
- Ensure that every participant answer all questions.

Activity



- Tell participants they have to prepare a power-point presentation on MS PowerPoint Software.
- Tell them they need to perform following operations while working on this software, Saving a PowerPoint, View tabs, Animating text and Images and inserting Charts.
- Give them one and half hour to prepare the same.
- Finally share some tips for correct typing and summarize the highlights of the activity.

Skill Practice	Time	Resources
1. Presentation on MS PowerPoint	4 Hours	<ul style="list-style-type: none">• Participant Manual• Computer Lab

Unit 7.7: MS Excel

Objectives

At the end of the unit, students will be able to:

- Work on MS-Excel
- Format cells and cell content
- Use formulas
- Make Charts and Pivot Table.

Resources to be used

- Participant Manual
- Computer System

Do

- Greet and welcome the participants to the next session of the program.
- Before starting the session ask them do they have any doubts pertaining to the previous unit.
- Acknowledge their responses and clear their doubts if any.
- Tell them they will learn about Ms Excel in this unit.

Say

- Tell them about the power point. MS Excel stands for - Microsoft Excel is one of the most popular electronic spreadsheet applications supported by both Mac and PC platforms. As with a paper spreadsheet, you can use Excel to organize your data into rows and columns and to perform mathematical calculations.
- Discuss the application of Excel with the participants.

Demonstrate

- Tell them to open MS Excel in their respective systems.
- Show them how to create a spread sheet in MS Excel software.
- Practically demonstrate how to perform different operations on MS Excel as:
 - Zoom in and Zoom Out
 - Page Views
 - Change the default excel options
 - Add Command to the quick access tool bar
 - Change the default excel options
 - Cell Addresses
 - Move Across a worksheet using key board
 - Formatting
 - Calculation and Analysis
 - Change page orientation
 - Aligning Text

Notes for Facilitation



- Summarize the main points of the unit.
- Ask participants if they have any doubts. Encourage them to ask questions.
- Answer their queries satisfactorily.
- Ask them to answer the questions at the end of unit given in the participant's manual.
- Ensure that every participant answer all questions.

Activity



- Tell participants they have to prepare a spread sheet on MS Excel Software.
- Share data of a class with the participants in which participants name, height, weight and age is given.
- Tell them they need to perform following operations while working on, Add Command to the quick access tool bar, Change the default excel options, Cell Addresses, Move Across a worksheet using key board, Formatting, Calculation and Analysis, Change page orientation
- Give them one and half hour to prepare the same.
- Finally share some tips for correct data typing and summarize the highlights of the activity.

Skill Practice	Time	Resources
1. Preparing Spread Sheet on MS Excel	4 Hours	<ul style="list-style-type: none"> • Participant Manual • Computer Lab with MS Office Software

Unit 7.8: Internet Concepts

Objectives

At the end of the unit, students will be able to:

- Understand internet concepts.
- Recognize the different types of URLs.
- Use MS-Outlook.

Resources to be used

- Participant Manual
- Computer with Internet

Do

- Greet and welcome the participants to the next session of the program.
- Before starting the session ask them do they have any doubts pertaining to the previous unit.
- Acknowledge their responses and clear their doubts if any.
- Tell them they will learn about internet concept in this unit.

Say

- Tell them about internet and its uses.
- Explain the concept of URL. The full form of URL is Uniform Resource Locator. It is the global address of documents and other resources on the World Wide Web. The URL is divided into two different parts. The first part of the URL is called a protocol identifier as it helps us identifying what protocol to use.
- Now tell them about different types of URLs.

Demonstrate

- Tell them now they will learn how to open an email account in outlook.
- Demonstrate the entire process to the participants. Make sure every student should open an e-mail account.
- Now tell them how to create and send an e-mail. Explain the entire steps in detail.
- Now show them how to read an email and reply email
- Then explain attachment. The process of attaching a file or document.

Notes for Facilitation

- Summarize the main points of the unit.
- Ask participants if they have any doubts. Encourage them to ask questions.
- Answer their queries satisfactorily.
- Ask them to answer the questions at the end of unit given in the participant's manual.

Activity



- Tell participants they have send emails to other participants with an attachment.
- Tell them first they need to create a word, excel or power point. They can choose between any three of the formats.
- Give 2 hours for each participant for this entire activity.
- Once activity is complete share some tips of e-mail etiquette with them and summarizes the highlights of the activity.

Skill Practice	Time	Resources
1. Send e-mail with attachment	2Hours	<ul style="list-style-type: none">• Computers with Internet



Skill India
कौशल भारत - कुशल भारत



सत्यमेव जयते
GOVERNMENT OF INDIA
MINISTRY OF SKILL DEVELOPMENT
& ENTREPRENEURSHIP



N · S · D · C
National
Skill Development
Corporation

Transforming the skill landscape



Media & Entertainment Skills Council

8. Employability & Entrepreneurship

- Unit 8.1 – Personal Strengths & Value Systems
- Unit 8.2 – Digital Literacy: A Recap
- Unit 8.3 – Money Matters
- Unit 8.4 – Preparing for Employment & Self Employment
- Unit 8.5 – Understanding Entrepreneurship
- Unit 8.6 – Preparing to be an Entrepreneur

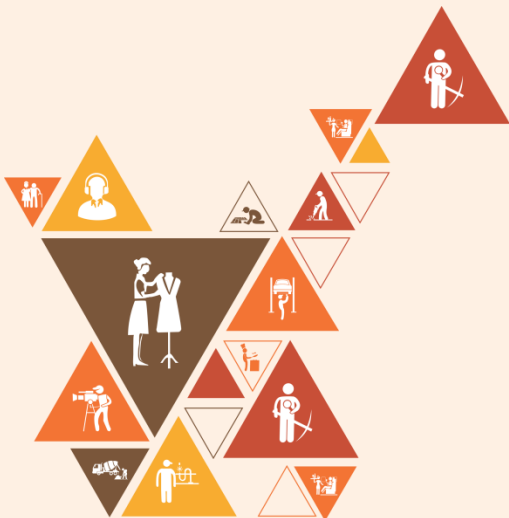

Introduction: Employability and Entrepreneurship Skills

This Facilitator's guide includes various activities which will help you as a facilitator to make the sessions participative and interactive.

Ice breaker

- You can begin the module with the following ice breaker:

Five of Anything Ice Breaker Steps:

- Divide the participants into groups of four or five by having them number off. (You do this because people generally begin a meeting by sitting with the people they already know best.)
- Tell the newly formed groups that their assignment is to share their five favorite movies of all time, their five favorite novels or their five least liked films. The topic can be five of anything - most liked or disliked.
- This ice breaker helps the group explore shared interests more broadly and sparks lots of discussion about why each person likes or dislikes their selected five.
- Tell the groups that one person must take notes and be ready to share the highlights of their group discussion with the class upon completion of the assignment.

Expectation Mapping

1. During the first session and after ice breaker session, ask the participants to answer the following question: "What do I expect to learn from this training?"
2. Have one of the participants write their contributions on a flip chart sheet.
3. Write down your own list of covered material in the training on another flip chart sheet.
4. Compare the two sheets, commenting on what will and what will not be covered during the training.
5. Set some ground rules for the training sessions. Ask the participants to put these rules on a flipchart and display it in the class.
6. You may get back to those sheets once again at the end of the last session of the training.
7. Benefits of doing this activity:
 - Participants feel better as their opinions are heard.
 - Participants get to know what they should expect from the training.
 - The facilitator gets to know which points to emphasize, which to leave out, and which to add during the training.
8. Expectations from the participants:
 - Must sign the attendance sheet when they arrive for class.
 - Conduct themselves in a positive manner
 - Be punctual, attentive, and participative
9. Explain the contents that are going to get covered one by one and connect it with the expectation mapping done earlier.
10. By the end of this exercise, the participants should have a clear understanding of what to expect from the session and what are the areas that will not get covered.

Defining Objectives

1. Defining the objectives in the beginning of the units sets the mood for the unit.
2. To begin with the end in mind sets the expectations of the participants as what could be the important takeaways from the session.
3. It is also a way of making participants take responsibility of their own learning process.
4. For the facilitator, the objectives decide a designed path to progress on so that the learning stays aligned and on track.
5. Read the objectives slowly, one by one, and ask the participants to explain what they think it means.
6. At the end of the session, you could again revisit the objectives to find out from the participants about how many objectives have been achieved.

In order to effectively facilitate this workshop:

1. You must have thorough knowledge of the material in the Participant Handbook, and be prepared to answer questions about it.
2. You may also wish to read other material to enhance your knowledge of the subject.
3. There may be issues raised with which you are not able to deal, either because of lack of time or knowledge. You can either state that you will obtain answers and get back to the participants with the information. In case the query can be turned to an assignment to the class, do so. You can work with the participants on the assignment.
4. You must have a very clear understanding of what the participants want to accomplish by the end of the workshop and the means to guide the participants.
5. As the facilitator, it is your responsibility to make sure that all logistical arrangements are made for the workshop. This may involve doing it yourself or confirming that someone else has made all necessary arrangements associated with the workshop. Assume nothing and check everything before the workshop begins.
6. To break the monotony and boredom during sessions, introduce mini breaks in the form of stretching exercises, jokes, some group songs or games.
7. Invite discussion from the participants.
8. Probe the participants further and lead them to come to affirmative conclusions.
9. Let the participants answer. No answer is incorrect.
10. Ask one participant to write all the points on the whiteboard.
11. Build the sessions from the answers provided by the class.
12. Prepare for the sessions in advance so that the resources like flipcharts, handouts, blank sheets of paper, marker pens, etc. can be kept ready.
13. Ensure that resources like board, markers, duster etc. is available before your session starts.

General instructions for role playing:

1. You are not being asked to be an actor or to entertain. The purpose of the role play is to provide a situation in which you can practice certain skills.
2. When you read the brief, try to imagine yourself in the situation described and behave in a way you feel to be natural – but be conscious of the fact that your role may require a different approach from that which you might normally use.
3. You (and others) may benefit from the change in approach and behavior. Therefore, try to use the approach you feel to be most appropriate for the circumstances described in your brief.
4. The brief is just the starting point. It simply sets the scene and the tone of session or activity. Try not to keep referring to the brief as this will affect the spontaneity of the meeting. Allow the role play to develop as you think it might in real life and change your reactions in line with the behavior and responses of others involved.
5. If you find that you have too little information to answer questions or to describe what has happened in the situation, do feel free to add your own thoughts and ideas. Try to keep these within the framework of the role you are taking and try to make your improvisations as realistic as possible.

UNIT 8.1: Personal Strengths & Value

Key Learning Outcomes



At the end of this unit, participants will be able to:

- Explain the meaning of health
- List common health issues
- Discuss tips to prevent common health issues
- Explain the meaning of hygiene
- Discuss the purpose of Swacch Bharat Abhiyan
- Explain the meaning of habit
- Discuss ways to set up a safe work environment
- Discuss critical safety habits to be followed by employees
- Explain the importance of self-analysis
- Discuss motivation with the help of Maslow's Hierarchy of Needs
- Discuss the meaning of achievement motivation
- List the characteristics of entrepreneurs with achievement motivation
- List the different factors that motivate you
- Discuss the role of attitude in self-analysis
- Discuss how to maintain a positive attitude
- List your strengths and weaknesses
- Discuss the qualities of honest people
- Describe the importance of honesty in entrepreneurs
- Discuss the elements of a strong work ethic
- Discuss how to foster a good work ethic
- List the characteristics of highly creative people
- List the characteristics of highly innovative people
- Discuss the benefits of time management
- List the traits of effective time managers
- Describe effective time management technique
- Discuss the importance of anger management
- Describe anger management strategies
- Discuss tips for anger management
- Discuss the causes of stress
- Discuss the symptoms of stress
- Discuss tips for stress management

UNIT 8.1.1: Health, Habits, Hygiene: What is Health?

Objectives

At the end of this unit, participants will be able to:

- Explain the meaning of health
- List common health issues
- Discuss tips to prevent common health issues
- Explain the meaning of hygiene
- Discuss the purpose of Swachh Bharat Abhiyan
- Explain the meaning of habit

Resources to be used

- Participant Handbook

Ask

- What do you understand by the term “Health?”
- According to you, who is a healthy person?

Say

- Discuss the meaning of health and a healthy person as given in the Participant Handbook.

Ask

- When did you visit the doctor last? Was it for you or for a family member?

Say

- Discuss the common health issues like common cold, allergies etc. Refer to the Participant Handbook.
- Let us do a small activity. I will need some volunteers.

Role Play

- Conduct a small skit with volunteers from the class. Consider one of the villagers has been appointed as a health representative of the village, what measures you as a health representative will suggest to the common villagers to prevent common health issues discussed.
- You will need at least 4 volunteers (Narrator, Health Representative, Head of the Village, Doctor).
- Explain the health concerns of the village to the Narrator. The Narrator will brief the class about the skit.
- Give the group of volunteers, 5 minutes to do discuss.
- At the end of 5 minutes, ask the group to present the skit to the class assuming them as the villagers.
- The class can ask questions to the group as a common villager.

Summarize

- Through this activity we got some tips on how can we prevent these common health issues.

Say

- Let us now see how many of these health standards we follow in our daily life.

Activity

- Health Standard Checklist from the Participant Handbook.

Ask

- How many of you think that you are healthy? How many of you follow healthy habits?

Say

- Let's do an exercise to find out how healthy you are.
- Open your Participant Handbook section 'Health, Habits, Hygiene: What is Health?', and read through the health standards given.
- Tick the points which you think are true for you.
- Try to be as honest as possible as this test is for your own learning.

Do

- Ensure that all the participants have opened the right page in the Participant Handbook.
- Read aloud the points for the participants and explain if required.
- Give them 5 minutes to do the exercise.
- At the end of 5 minutes, ask the participants to check how many ticks have they got.

Summarize

- Tell them that they need to follow all the tips given in this checklist regularly in order to remain healthy and fit.

Ask

Discuss:

- Is it necessary to practice personal hygiene every day? Why?
- How does a person feel when they do not practice good personal hygiene? Why?
- Can good personal hygiene help a person feel good about his/her self? How?

Say

- Discuss the meaning of hygiene as given in the Participant Handbook.

Activity

- Health Standard Checklist: Hygiene

Say

- Let's do an exercise to find out if we maintain good hygiene habits or not.
- Open the Participant Handbook and read through the Health Standard checklist given.
- Tick the points which you think are true for you.
- Try to be as honest as possible as this test is for your own learning.

Do

- Ensure that all the participants have opened the right page in the Participant Handbook.
- Read aloud the points for the participants and explain if required.
- Give them 5 minutes to do the exercise. .
- At the end of 5 minutes, ask the participants to check how many ticks have they got.
- Ask them to calculate their score.
- Tell them what each score indicates by reading aloud what has been mentioned in the Participant Handbook.

Ask

- How many of you have heard about “Swachh Bharat Abhiyan”?
- Can you tell the class what it is about?

Summarize

- Tell them about Swachh Bharat Abhiyan as given in the Participant Handbook and request them to take a pledge to keep our country clean.

Ask

- What is a habit?

Say

- Discuss some good habits which can become a way of life.

Summarize

- Tell them about good and bad habits and the reasons to make good habits a way of life.

UNIT 8.1.2: Safety

Objectives

At the end of this unit, participants will be able to:

- Discuss ways to set up a safe work environment
- Discuss critical safety habits to be followed by employees

Resources to be used

- Participant Handbook
- Safety signs and symbols
- Safety equipments
- Blank papers
- Pens

Say

- There are many common safety hazards present in most workplaces at one time or another. They include unsafe conditions that can cause injury, illness and death.
- Safety Hazards include:
 - Spills on floors or tripping hazards, such as blocked aisles or cords running across the floor.
 - Working from heights, including ladders, scaffolds, roofs, or any raised work area.
 - Unguarded machinery and moving machinery parts; guards removed or moving parts that a worker can accidentally touch.
 - Electrical hazards like cords, missing ground pins, improper wiring.
 - Machinery-related hazards (lockout/tag out, boiler safety, forklifts, etc.)

Team Activity

Safety Hazards

- There are two parts to this activity.
- First part will cover the potential safety hazards at work place.
- Second part will cover a few safety signs, symbols and equipments at work place.
- Use this format for the first part of the activity.

PART 1		
Hazard	What could happen?	How could it be corrected?

Ask

- How could you or your employees get hurt at work?

Say

- Let's understand it better with the help of an activity. You will be given a handout within your groups. You have to think about the possible hazards of your workplace, what damage these hazards could cause and about the corrective action.

Do

- Divide the class into five to six groups of four participants each.
- Put the format on the board for the activity.
- Give blank papers and pens to each group.
- The group is expected to think and discuss the potential safety hazards in the workplace.
- Ask the group to discuss and fill the format using the blank sheet.
- Give the groups 5 minutes for the activity.
- For the second part of the activity, show the class some pictures of safety signs, symbols and equipments.
- Now they will put down a few safety symbols, signs or equipment against the safety hazards identified.
- Give them 5 to 10 minutes to discuss and draw/note it.
- At the end of 10 minutes the groups will present their answers to the class.

Say

- Now, let's discuss the answers with the class.
- All the groups will briefly present their answers.

Do

- Ask the audience to applaud for the group presentation.
- Ask de-brief questions to cull out the information from each group.
- Keep a check on time.
- Tell the group to wind up the discussion quickly if they go beyond the given time limit.

Ask

De-briefing

- What did you learn from the exercise?
- As an entrepreneur, is it important to ensure the safety of your employees from possible hazards? Why?

Summarize

- Ask the participants what they have learnt so far.
- Ask if they have any questions related to what they have talked about so far.
- Close the discussion by summarizing the tips to design a safe workplace and non-negotiable employee safety habits.

UNIT8.1.3: Self Analysis- Attitude, Achievement Motivation: What is Self-Analysis?

Objectives

At the end of this unit, participants will be able to:

- Explain the importance of self- analysis
- Discuss motivation with the help of Maslow's Hierarchy of Needs
- Discuss the meaning of achievement motivation
- List the characteristics of entrepreneurs with achievement motivation
- List the different factors that motivate you
- Discuss the role of attitude in self- analysis
- Discuss how to maintain a positive attitude
- List your strengths and weaknesses

Resources to be used

- Participant Handbook
- Old newspapers
- Blank papers
- Pencils/ pens

Activity

- This is a paper pencil activity.
What are the three sentences that describe you the best?
What do you need to live happily?
What are your strengths and weaknesses?

Do

- Write the three questions on the board/ flipchart before the session begins.
- Give plain papers and pencils/ pens to each participant.
- Tell participants to write the answer for the three questions on the paper.
- Tell them the purpose of this activity is not to judge anyone but to understand more about self.

Say

- Discuss the concept of Self Analysis and motivation with reference to Maslow's Hierarchy of Needs as discussed in the Participant Handbook.

Team Activity

Tower building

- Each group which will create tower using the old newspapers.

Do 

- Divide the class into groups.
- Give them some old newspapers.
- The task is to create a tower out of the newspapers.
- The group which will create the highest tower standing on its own will be considered the winning group.
- Groups can use as many newspapers as they want to and in any way they want.

Ask

- What did the winning group do differently?
- If you were given a chance, how would you have made the tower differently?
- How did you feel while making the tower?
- Did you feel motivated?

Say 

- Discuss the concept of achievement motivation and characteristics of entrepreneurs with achievement motivation as discussed in the Participant Handbook.

Ask

- Is your attitude positive or negative?

Say 

- Let me tell you a story :

It's Little Things that Make a Big Difference.

There was a man taking a morning walk at the beach. He saw that along with the morning tide came hundreds of starfish and when the tide receded, they were left behind and with the morning sun rays, they would die. The tide was fresh and the starfish were alive. The man took a few steps, picked one and threw it into the water. He did that repeatedly. Right behind him there was another person who couldn't understand what this man was doing. He caught up with him and asked, "What are you doing? There are hundreds of starfish. How many can you help? What difference does it make?" This man did not reply, took two more steps, picked up another one, threw it into the water, and said, "It makes a difference to this one." What difference are we making? Big or small, it does not matter. If everyone made a small difference, we'd end up with a big difference, wouldn't we?

Ask

- What did you learn from this story?

Activity 

- What Motivates You?
- This is an individual activity.

Do 

- Ask the class to open their Participant Handbook and complete the exercise given in the section What Motivates You?
- Ensure that the participants have opened the correct page for the activity.
- Give the class 5 minutes to complete the activity.

Say 

- Discuss the concept of attitude and how to cultivate a positive attitude as discussed in the Participant Handbook.

Summarize

- Close the discussion by summarizing how self-analysis, knowledge about what motivates you and your positive attitude can help in your business as well in life.

UNIT 8.1.4: Honesty & Work Ethics

Objectives

At the end of this unit, participants will be able to:

- Discuss the qualities of honest people
- Describe the importance of honesty in entrepreneurs
- Discuss the elements of a strong work ethic
- Discuss how to foster a good work ethic

Resources to be used

- Participant Handbook

Ask

- What do you understand by honesty?
- Why is it important for entrepreneurs to be honest?
- Do you remember any incident where your honesty helped you in gaining confidence?
- Do you remember any incident where someone lost business due to dishonesty?

Say

- Talk about honesty, qualities of an honest person, and the importance of honesty in entrepreneurs as discussed in the Participant Handbook.
- “Let's understand it better with the help of some case scenarios. You will be given some cases within your groups. You have to analyze the case scenario that has been given to you and then find an appropriate solution to the problem.
- Keep your discussion focused around the following:
 - What went wrong?
 - Who was at fault?
 - Whom did it impact- the customer or the businessman?
 - How would it impact the business immediately? What would be the long term impact?
 - What could be done?
 - What did you learn from the exercise?

Do

- Divide the class into four groups of maximum six participants depending on the batch size.
- Give one case study to each group.
- Instruct them to read the case carefully.
- Put down the de-brief questions on the board and ask the groups to focus their discussion around these questions.
- The group is expected to analyze and discuss the case amongst them and find a solution to the given problem. Give the class 5-10 minutes to discuss the case and note down their solutions.
- At the end of 10 minutes the team should present their case solution to the class. The presentation can be a narration or a role play.
- Ask the group to select a group leader for their group. The group leader to discuss and assign roles to the group members for the presentation.

Team Activity

Case Study Analysis

Scenario 1

Aakash has a small mobile retail sales and repair shop in Allahabad. He has one of the most popular outlets and has great rapport with his customers.

It's around 11 AM when a customer barges in to the shop and starts shouting at Aakash for giving her a faulty instrument. The screen of her mobile is cracked from one side. Aakash remembered thoroughly checking the handset before handing it over to the customer. The customer threatens to sue him and to go to Consumer Court for cheating her. Now, the problem occurred somewhere outside the shop but as other customers were listening to the conversation, it might impact his business. The situation needs to be managed very sensitively. What would you do if you were in Aakash's place?

Scenario 2

Rajni does beautiful Phulkari embroidery on suits and sarees. She has a small home-based business. She has a huge list of customers on Facebook and WhatsApp who give her orders regularly. Smita is one of her old and regular customers. As her sister-in-law's wedding was around the corner, Smita wanted to buy few handcrafted Phulkari duppatta. She placed an order for three duppattas via WhatsApp and requested Rajni to send them as soon as possible. When the parcel reached Smita through courier she found that out of the three duppattas, only one was hand embroidered and the other two had machine embroidery on them. Even the length and the quality of the material was not as desired. Smita was heartbroken. It was a complete waste of money and moreover she couldn't wear what she had planned to during the wedding functions. She sent a message to Rajni on WhatsApp, expressing her anger and disappointment.

Smita has also sent a feedback and expressed her disappointment on the social media... this will directly affect Rajni's business. What would you do if you were in Rajni's place?

Scenario 3

Shankar is a tattoo artist who has a small tattoo showroom in a big, reputed mall in New Delhi. Mr. Saksham had an appointment for today, at 11:00 am but he reached at 11:50 am. Meanwhile, Shankar had to reschedule his next appointment. After availing Shankar's services, Mr. Saksham started yelling in an abusive language, refusing to pay the requisite amount, and finding faults in the services provided by him. Who was at fault in this case? What should Shankar do? Should he confront Saksham or give in to the demands of the client?

Scenario 4

Shailender is an online cloth reseller who does business through social networking sites such as Facebook and WhatsApp. Priyanka made online payment for a dress to Shailender. But she did not receive the dress for a month. When she asked for a cancellation, Shailender started misleading her. For almost 45 days, he kept promising her that he will pay the amount today, tomorrow, day after etc. Even after repeated calls and messages when she did not receive the payment or the dress, she decided to write a post against him on a popular social media platform. As a result, Shailender lost lots of customers and his flourishing business faced a major crisis. How could this situation have been managed?

Say

- Now, let's discuss the problem and solution with the larger group.
- The group will first briefly describe the case to the class.
- Then discuss the issue identified and the proposed solution.
- Once the presentation is over, the class can ask their questions.

Do

- Congratulate each group for the group presentation.
- Ask the audience to applaud for them.
- Ask de-brief questions to cull out the information from each group.
- Keep a check on time. Tell the group to wind up the discussion quickly if they go beyond the given time limit.

Summarize

- Ask the participants what they have learnt from the exercise/ activity.
- Ask if they have any questions related to what they have talked about so far.
- Close the discussion by summarizing the importance of honesty and work ethics for entrepreneurs.

UNIT 8.1.5: Creativity and Innovation

Objectives

At the end of this unit, participants will be able to:

- List the characteristics of highly creative people
- List the characteristics of highly innovative people

Resources to be used

- Participant Handbook
- Chart papers
- Marker pens

Ask

- You must be aware of the term 'Rags to riches' and heard stories related to the term.
- What do these stories tell us?
- What was so special about these people?

Say

- Let's have a look at these stories.
- There are some inspiring stories about people which I would like to share with you.
- Narrate these stories to the class.

A.P.J. Abdul Kalam

Who has not heard of A.P.J. Abdul Kalam: AvulPakirJainulabdeen Abdul Kalam hailed from a very humble background. His father was a boat owner. To help his family, Kalam would work as a newspaper vendor. With limited resources, he graduated in Physics and studied aerospace engineering. He was instrumental in India's step towards nuclear energy. In 2002, he became the 11th President of India.

Water filter/purifier at source

Two young boys studying in classes 4 and 5, from Lingzya Junior High School, Sikkim designed a simple innovative low cost water purifier.

Inspiration behind the idea: Most people today prefer to use a water filter/purifier at their home.

Both the children have given idea to have filter/purifier at the source of water so that everyone has access to clean water without having to make an investment in purchasing a filter/purifier.

Soring's idea is to have a centralized purification system at the point of distribution like water tank while Subash's idea is to have such purifiers attached to public taps.

Source:<http://www.rediff.com/getahead/report/achievers-top-31-amazing-innovations-from-young-indians/20151208.htm>

Solar seeder

This is a story of an innovative solar seeder and developed by Subash Chandra Bose, a class 8, student from St Sebasthiyar Matriculation School, Pudukkottai, Tamil Nadu. Subash has developed a solar powered seed drill, which can undertake plantation for different size of seeds at variable depth and space between two seeds.

Source:<http://www.rediff.com/getahead/report/achievers-top-31-amazing-innovations-from-young-indians/20151208.htm>

Looms for physically challenged

Now this is really inspiring of two sisters, Elakkiya a Class 6 student and Pavithra a Class 9 student of SRC Memorial Matriculation, Erode, Tamil Nadu.

The two sisters have come up with loom for lower limbed physically challenged. In their loom they have replaced the pedal operated system with a motor and a gearbox attached to a pulley mechanism.

Source:<http://www.rediff.com/getahead/report/achievers-top-31-amazing-innovations-from-young-indians/20151208.htm>

Ask

- If they can, why can't you?
- Discuss concepts related to 'Creativity and Innovation' with the participants as given in the Participant Handbook.

Say

- Recall the stories on motivation.
- What is the inner drive that motivates people to succeed?
- Let's learn more about such creative and innovative entrepreneurs with the help of an activity.

Team Activity

- This is a group activity.
- Think of any one famous entrepreneur and write a few lines about him or her.

Activity De-brief

- Why did you choose this particular entrepreneur?
- What is his/her brand name?
- What creativity does he/she possess?
- What was innovative about their ideas?

Do

- Instruct the participants that this is group work.
- Divide the class into small groups of 4 or 6 depending on the batch size.
- Give each group a chart paper.
- Tell the participants they have to write a few lines about any one famous entrepreneur.
- Give the participants 10 minutes to discuss and write.
- Keep a check on time. Tell the group to wind up quickly if they go beyond the given time limit.
- Ask each group to read out what they have written.
- Ask the de-brief questions.

Summarize

- Summarize the unit by asking participants if they know of some people who are highly creative and innovative in their approach.
- Ask them to share some experiences about these people with the class.

Notes for Facilitation



- Source for stories on innovations:

<http://www.rediff.com/getahead/report/achievers-top-31-amazing-innovations-from-young-Indians/20151208.htm>

UNIT 8.1.6: Time Management

Objectives

At the end of this unit, participants will be able to:

- Discuss the benefits of time management
- List the traits of effective time managers
- Describe effective time management techniques

Resources to be used

- Participant Handbook

Ask

- Does this sound like you?
- I can never get enough time to finish what I am doing in a day.
- I have so many things to do that I get confused.
- I want to go for a walk and exercise, but I just do not have the time.
- I had so much to do, so I could not deliver that order on time.
- I would love to start my dream business; but, I just do not have the time.

Example

- Let's look at these two examples:

Example 1:

Ankita works from home as a freelance writer. She says she can easily put in 8 hours of dedicated work in a day. Because she works from home, she saves money on travel and has a comfortable work routine. But there is a challenge and it is distraction. As she works from home, she can easily just get up and sit down on the sofa to watch TV, wasting valuable time. She may have chores to do, errands to run and bills to pay. She ends up working only two to three hours a day and the result is, her work gets piled up. She is unable to take on more work due to this. Even though her quality of work is appreciated her clients are not very happy about the delay in submission.

Example 2:

Javed has started a successful online selling company from home and makes a good living from his sales. He has set up a small office space in his living room. As both his parents are working full-time, he also has the role of taking care of his two younger siblings. He almost spends half of his day with the younger kids. He does not mind it but it means taking time away from the work. He is still able to manage his online business with these commitments. He wants to spend some more dedicated hours so as to increase his profits. He also wants to look into new business avenues. What should he be doing.

Ask

- Does this happen with you too?
- Do you find it difficult to prioritize your work?
- Are you able to manage your time effectively?

Activity



- Conduct a group discussion based on the above examples.
- Direct the discussion on how to prioritize work and manage time effectively.

Say



- Time management is not only about how hard you work but also about how smart you work.
- Discuss “What is Time Management” with the participants as given in the Participant Handbook.

Ask

- Why is it important to manage time? How does it help?
- What happens when you don't manage your time effectively?
- Do you find it difficult to prioritize your work?

Say



- Discuss the benefits of time management given in the Participant Handbook.
- Let's learn effective time management with the help of an activity.

Activity



Effective Time Management

- This activity has two parts:

PART 1 TO-DO LIST

- You have to make a to-do list.
- List all of the activities/ tasks that you have to do.
- Try to include everything that takes up your time, however unimportant it may be.
- If they are large tasks, break them into action steps, and write this down with the larger task.
- You can make one list for all your tasks or have separate to-do lists for personal and professional tasks.

PART 2 URGENT-IMPORTANT GRID

- You have to make a grid as shown on the board here. .
- This grid has four boxes. As you can see, each box has a different heading.
- At the heart of the urgent-important grid, are these two questions:
 - Is this task important?
 - Is this task urgent?
- Now, you have to think about each activity that you have written in your to-do list and put it into one of the four categories.
- What do these categories depict?
- Category 1: Urgent/Important
 - This category is for the highest priority tasks. They need to get done now.

- **Category 2: Not Urgent/Important**

- This is where you want to spend most of your time.
- This category allows you to work on something important and have the time to do it properly.

- This will help you produce high quality work in an efficient manner.
- The tasks in this category are probably the most neglected ones, but also the most crucial ones for success.
- The tasks in this category can include strategic thinking, deciding on goals or general direction and planning – all vital parts of running a successful business.

▪ **Category 3: Urgent/Not Important**

- This is where you are busy but not productive. These tasks are often mistaken to be important, when they're most often busywork.
- Urgent but not important tasks are things that prevent you from achieving your goals.
- However, some may be activities that other people want you to do.

▪ **Category 4: Not Important and Not Urgent**

- This category doesn't really include tasks, but rather habits that provide comfort, and a refuge from being disciplined and rigorous with your time management.
- Some may be activities that other people want you to do.
- These might include unplanned leisure activities as well.

TO- DO list format

1	
2	
3	
4	
5	
6	
7	
8	
9	
10	
11	
12	
13	
14	
15	

URGENT-IMPORTANT GRID

<p>URGENT/ IMPORTANT</p> <ul style="list-style-type: none"> • Meetings • Last minute demands • Project deadlines • Crisis 	<p>NOT URGENT/ IMPORTANT</p> <ul style="list-style-type: none"> • Planning • Working towards goals • Building relationship • Personal commitments
<ul style="list-style-type: none"> • Interruptions • Phone calls/ E-mails • Other people's minor demands <p>URGENT/ NOT IMPORTANT</p>	<ul style="list-style-type: none"> • Internet surfing • Social media • Watching TV <p>NOT URGENT/ NOT IMPORTANT</p>

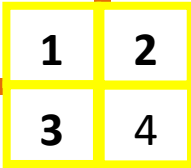

URGENT/ IMPORTANT GRID format

<p>URGENT/ IMPORTANT</p>	<p>NOT URGENT/ NOT IMPORTANT</p>
<p>URGENT/ NOT IMPORTANT</p>	<p>NOT URGENT/ NOT IMPORTANT</p>

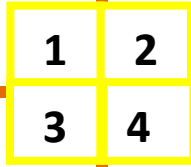

Do

- Put down the formats for the to-do list and the urgent/ important grid on the board.
- Instruct the participants to prepare their to-do list first.
- Give the participants 10 minutes to prepare the list.
- Once done, instruct them to divide the tasks in to-do list into the four categories.
- Explain the four categories to the participants giving examples specific to their context.
- As you explain the categories fill the grid with the type of tasks.
- Give the participants 40 minutes to fill the grid.
- Then explain how to balance the tasks between the four categories.
- Keep a check on time. Tell the group to wind up quickly if they go beyond the given time limit.

Say

Activity De-brief:

How can we balance tasks between the four categories?

How to manage time through this grid?

- **Category 1: Urgent/Important**
 - Try to keep as few tasks as possible here, with the aim to eliminate.
 - If you spend too much of your time in this category, you are working solely as a trouble shooter, and never finding time to work on longer-term plans.
- **Category 2: Not Urgent/Important**
 - Plan these tasks carefully and efficiently as they are most crucial ones for success.
 - If necessary, also plan where you will do these tasks, so that you're free from interruptions.
 - Include strategic thinking, deciding on goals or general direction and planning in your planning process.
- **Category 3: Urgent/Not Important**
 - Ask yourself whether you can reschedule or delegate them.
 - A common source of such activities is other people. Sometimes it's appropriate to say "no" to people politely, or to encourage them to solve the problem themselves.
- **Category 4: Not Important and Not Urgent**
 - You also want to minimize the tasks that you have in this category.
 - These activities are just a distraction – avoid them if possible.
 - You can simply ignore or cancel many of them.
 - Politely say "no" to work assigned by others, if you can, and explain why you cannot do it.
 - Schedule your leisure activities carefully so that they don't have an impact on other important tasks.
- Discuss the traits of effective time managers and effective time management techniques as given in the Participant Handbook.

Summarize

- Discuss the traits of effective time managers and effective time management techniques as given in the Participant Handbook.

Notes for Facilitation



- Here is a short story. You can conclude the session narrating the story. To make it more interesting you can perform the demonstration described and discuss the short story.
 - One day an expert in time management was speaking to a group of students. As he stood in front of the group, he pulled out a large wide-mouthed glass jar and set it on the table in front of him. Then he took out a bag of about a dozen rocks and placed them, one at a time, into the jar. When the jar was filled to the top and no more rocks would fit inside, he asked, "Is this jar full?" Everyone in the class said, "Yes." Then he said, "Really?"
 - He reached under the table and pulled out a bucket of gravel (small stones). He dumped some gravel in and shook the jar causing pieces of gravel to work themselves down into the space between the rocks. Then he asked the group once more, "Is the jar full?" By this time, the class began to understand. "Probably not," one of them answered. "Good!" he replied.
 - He reached under the table and brought out a bucket of sand. He started dumping the sand in the jar and it went into all of the spaces left between the rocks and the gravel. Once more he asked the question, "Is this jar full?" No!" the class shouted. Once again he said, "Good." Then he grabbed a jug of water and began to pour it in until the jar was filled to the brim. Then he looked at the class and asked, "What is the point of this illustration?" One student raised his hand and said, "No matter how full your schedule is, if you try really hard you can always fit some more things in it!" "No," the speaker replied, "that's not the point. The truth this illustration teaches us is: If you don't put the big rocks in first, you'll never get them in at all." What are the 'big rocks' in your life? Your children; your loved ones; your education; your dreams; a worthy cause; teaching or mentoring others; doing things that you love; time for yourself; your health; your mate (or significant other). Remember to put these BIG ROCKS in first or you'll never get them in at all. If you sweat about the little stuff (the gravel, sand, and water) then you'll fill your life with little things you worry about that don't really matter, and you'll never have the time you need to spend on the big, important stuff (the big rocks).
- End the story with these lines...
- So, tonight, or in the morning tomorrow, when you are reflecting on this short story, ask yourself this question: What are the 'big rocks' in my life? Then, put those in your jar first

Objectives

At the end of this unit, participants will be able to:

- Discuss the importance of anger management
- Describe anger management strategies
- Discuss tips for anger management

Resources to be used

- Participant Handbook

Ask

- What is anger? Is anger good or bad?
- Is anger normal or an abnormal behavior? How can anger harm you?
- Why is it important for entrepreneurs to manage their anger?

Say

- Talk about anger and the importance of anger management in entrepreneurs as discussed in the Participant Handbook.
- Let us do a small activity. This is an individual activity.
- Think of the incidents and situations that angered you and hurt you

Do

- Instruct them to note down these situations under different categories (as given in the Activity).
- Give the class 3-5 minutes to think and note down their answers.
- At the end of 5 minutes, ask some participants to volunteer and present their answers.
- They can also share these situations with their fellow participants if they do not wish to share it with the entire class.

Activity

- Do you remember any incident which has hurt
 - you physically
 - you mentally
 - your career
 - Your relationships.

Ask

- Do you ever get angry?
- What are the things that make you angry?
- Do you remember any incident where your anger management helped you in maintaining healthy relationship?
- Do you remember any incident where someone lost business/ friend/ relationship due to temper (anger)?

Say

- There are a few strategies which can help in controlling your anger. Let's do an activity to understand the anger management process better.
- This is an individual activity.
- Think of the incidents/ situations which trigger your anger (the cause).
- Then think what happened as a result of your anger (the effect).
- You need to come up with some techniques to manage your anger.

Do

- Give the class the anger triggers (the cause) as listed in the activity.
- Put down the activity format (Anger Triggers, Result of your Anger, Anger Management Techniques) on the board and instruct the class to write the answers under different categories.
- Give the class 3-5 minutes to think and note down their answers.
- At the end of 5 minutes, ask the participants who wish to volunteer and present their answers.

Activity

Trigger points and Anger Management Techniques Activity

Anger Triggers

List of triggers that make you angry:

Someone says you did something wrong.

You want something you can't have now.

You get caught doing something you shouldn't have been doing.

You are accused of doing something you didn't do.

You are told that you can't do something.

Someone doesn't agree with you.

Someone doesn't do what you tell him to do.

Someone unexpected happens that messes up your schedule.

Result of your anger:

--

Write the techniques that you use to manage your anger:

Anger Management Techniques

- Now **Say**  let's discuss the problems and solution with all.
- The individual will first briefly describe trigger points to the class.
- Then discuss the result of the anger. Other participants are requested to remain quiet while one is making the presentation.
- Post presentation, other participants may ask questions.

Do

- Congratulate each individual for sharing their points.
- Ask the audience to applaud for them.
- Ask de-brief questions after the presentation to the class.
- Keep a check on the time. Ask the participants to wind up the activity quickly if they go beyond the given time limit.

Ask

De-brief questions:

- In the situation described by the presenter, who was at fault?
- How could you have handled this situation alternatively?

Summarize

- Close the discussion by summarizing the strategies and tips of anger management for entrepreneurs.
- Ask the participants what have they learnt from this exercise/ activity.
- Ask if they have any questions related to what they have talked about so far.

Notes for Facilitation

- Encourage the participants to share information about them while presenting the situations to the class.
- Keep the format of the Activity prepared in a chart paper so that it can be displayed during the session.

UNIT 8.1.8: Stress Management: What is stress?

Objectives

At the end of this unit, participants will be able to:

- Discuss the causes of stress
- Discuss the symptoms of stress
- Discuss tips for stress management

Resources to be used

- Participant Handbook

Ask

- You are waiting in the reception for an interview or a very important meeting, suddenly your legs are shaky, your hands are cold, you are feeling nervous. Have you ever been in this kind of situation?
- Have you had days when you had trouble sleeping?
- Have you ever been so worried about something that you ended up with a terrible headache?

Say

- You've probably heard people say, "I'm really stressed out" or "This is making me totally stressed."

Ask

- What do you understand by stress?
- What gives you stress?
- How do you feel when you are stressed or what are the symptoms of stress?
- How can stress harm you?
- Why is it important for entrepreneurs to manage stress?

Say

- When we feel overloaded or unsure of our ability to deal with certain challenges, we feel stressed.
- Discuss about stress, causes of stress, and symptoms of stress as discussed in the Participant Handbook.
- Let's understand the causes of stress and how to deal with them with the help of some case scenarios.
- You will be given some cases.
- You have to analyze the case scenario and then find an appropriate solution to the problem.
- This will be a group activity.

Do

- Divide the class into four groups of 5- 6 participants (depending on the batch size).
- Assign one case scenario to each group.
- Instruct them to read the case carefully.
- The group is expected to analyse and discuss the case amongst them and find a solution to the given problem.

- Explain their discussion should result in getting answers for the following questions:
 - What was/ were the cause(s) of stress?
 - Was the stress avoidable or manageable under the given circumstances?
 - If yes, how do you think that the stress could be avoided (managed)?
 - If no, then why not?
- Give the class 10-12 minutes to discuss the case and note down their solutions.
- At the end of 12 minutes, the team should present their case solution to the larger group.
- Ask the group to select a group leader for their group.
- The group leader to discuss and assign roles to the group members for the presentation.

Team Activity

Case Study Analysis

Scenario 1

Akash's alarm doesn't go off and he gets late getting out of the house. He hits traffic and ends up 15 minutes late to work, which his boss notices. He gets to his desk and finds he has to complete 2 reports in next one hour. Just when he is about to begin work, a message pops up "Telecom with the client begins in 10 minutes. Please be in the conference room in 5 minutes."

His is not prepared for the call. He is stressed. He does not want to speak to his boss about this. He is stressed, feeling uncomfortable and sick. Not in a position to attend the call or finish the reports on time.

Scenario 2

While paying his overdue bills, Rahul realized that it's the middle of the month and he has only Rs 500 left in his account. He has already asked all of his friends, and family for loans, which he hasn't paid back yet. He is still contemplating over the issue when his phone rings. His sister's birthday is due next week and she has seen a beautiful dress which she wants to buy but cannot tell the parents as it is a bit expensive. She wishes if Rahul could buy the dress for her. Rahul has promised to buy her the dress for her birthday.

Rahul is stressed, does not understand what to do. He is unable to concentrate on his work and unable to complete the tasks assigned. His team leader has already warned him of the delay.

Scenario 3

Sheela calls the cable company as she has unknown charges on her bill. She has to go through the automated voice mail menu three times and still can't get through to a customer care executive. After 15 minutes of repeated efforts, her call is answered. She explains the entire issue to the customer care executive but before the person could suggest a way out, the call drops.

Now Sheela has to call back and repeat the whole process all over again with a new customer care executive. She is very angry and calls again but cannot connect this time.

She has to leave to office so she decides to call from office and check. When she connects this time she is angry and argues with the executive on the call. All her co-workers around are looking at her as her volume has suddenly increased. She bangs the phone and ends the call.

Her co-worker Neelam enquires what has happened to her. She ignores her and just walks off. She has become irritable and her behaviour and tone with other co-workers is not acceptable.

Scenario 4

Arpit is a young entrepreneur who started doing business through Facebook few weeks back. He had always been into a job. Although Arpit has very few financial liabilities, it wasn't an easy decision to leave a comfortable job at once and look for newer pastures. Arpit's boss warned him of the consequences and the challenges of starting a business when nobody ever in his family had been in business.

He has not been able to get a good deal till now. This is an important life shift for him which comes with unknown variables. Arpit is nervous and is wondering if he has what it takes to fulfill the requirement of his new role, or the new experiences he's likely to face.

Ask

De-brief questions:

- What was/ were the cause(s) of stress?
- Was the stress avoidable or manageable under the given circumstances?
- If yes, how do you think that the stress could be avoided (managed)?
- If no, then why not?

Say

- Now, let's discuss the problem and solution with the larger group.
- The group will first briefly describe the case to the class.
- Then discuss the issue identified and the proposed solution.
- Post presentation, the other groups may ask questions to the group that has presented.

Do

- Congratulate each group for sharing their points.
- Ask the audience to applaud for them.
- Ask de-brief questions to cull out the information from each group.
- Keep a check on time. Tell participants to wind up the discussion quickly if they go beyond the given time limit.

Say

- While it is common and normal to feel some tension. This feeling nervous and tensed can interfere with your thinking process and can have a negative impact on your performance.
- Stress can deplete the most vibrant of souls. It can have a negative effect on every aspect of a person's life including their health, emotional well-being, relationships, and career. However, one needs to understand the causes and types of stress before looking for ways to manage it.

De-brief:

Scenario 1

The cause of stress was lack of time management and the habit of procrastinating. If Akash would have managed his time well, planned alternate ways to get up on time, finished prior tasks on time and planned for client meetings in advance then he wouldn't have faced stress.

Scenario 2

The cause of stress was lack of financial planning. Rahul should have planned his financial resources well in advance and saved some money for the rainy day. Also, differentiating between needs and wants and keeping a check on non-essential expenditure would have saved Rahul from this situation.

Scenario 3

Sometimes, stress is caused due to external factors instead of internal ones. In this case, the stress was unavoidable because we have no control over this customer care system. Every time, you will get in touch with a new executive and will have to explain all over again. This might cause stress but despite being frustrated and angry there is little that we can do about it. All Sheela could do was to find ways to calm herself down through some breathing exercises and meditation, reading some good book or listening to music and then start afresh.

Scenario 4

A positive, major life change can be a source of good stress. Regardless of how good the change is, it can be stressful. Stress caused by a positive and major life change can be beneficial because it causes a person to step out of their comfort zone and learn new skills. Here, Arpit may become a successful entrepreneur or learn new ways to do things differently.

Now let us see this scenario, can I have a volunteer to read out this case to the class.

Do

- Ask one of the participants who can volunteer and read out this scenario to the class.

Scenario 5

Rakesh lives in Kathmandu with his wife and two beautiful daughters Sarah and Sanya. Nepal was hit by a massive earthquake and Rakesh's building collapsed during the earthquake. During evacuation, Rakesh realised that though his wife and Sarah were fine and suffered only minor bruises, Sanya was nowhere in the scene. Panic stricken, he started calling her name and searching her frantically. A little later, he heard a meek voice from beneath the debris. He quickly removed the rubble to find a huge bed. Rakesh was pretty sure that Sanya was trapped underneath. Though he was badly bruised, he gathered all his courage and with all his might, he lifted the several-ton bed to save Sanya's life. Everyone was relieved to see Sanya alive and also extremely surprised to see this father's ability to access superhuman strength.

- Ask the audience to applaud for the participant after the scenario is read completely.
- Discuss the scenario, ask de-brief questions:
 - What kind of stress was Rakesh undergoing in this case?
 - Was the stress avoidable or manageable under the given circumstances?
 - What was the result of the stress?

Say

De-brief:

- Not all stress is harmful; good stress is actually energizing. This was a case of lifesaving stress, or hero stress, which is an important example of good stress. You may have heard stories in which a person performs an impossible feat of physical strength in order to save their life or the life of someone they love. This type of stress causing a surge of adrenaline is good for us.

Summarize

- Close the discussion by summarizing the tips to manage stress as given in the Participant Handbook.
- Ask the participants what they have learnt from this exercise/ activity.
- Ask if they have any questions related to what they have talked about so far.

Notes for Facilitation

- Keep printed copies of the activities/ scenarios ready for the session.
- Put down the de-brief questions on a flip chart so that it can be displayed in the class during the activity.
- Encourage participation and make the discussions interactive.

UNIT 8.2: Digital Literacy: A Recap

Key Learning Outcomes



At the end of this unit, participants will be able to:

- Identify the basic parts of a computer
- Identify the basic parts of a keyboard
- Recall basic computer terminology
- Recall the functions of basic computer keys
- Discuss the main applications of MS Office
- Discuss the benefits of Microsoft Outlook
- Identify different types of e-commerce
- List the benefits of e-commerce for retailers and customers
- Discuss Digital India campaign will help boost e-commerce in India
- Describe how you will sell a product or service on an e-commerce platform

UNIT 8.2.1: Computer and Internet Basics: Basic Parts of a Computer

Objectives



At the end of this unit, participants will be able to:

- Identify the basic parts of a computer
- Identify the basic parts of a keyboard
- Recall basic computer terminology
- Recall the functions of basic computer keys

Resources to be used



- Participant Handbook
- Computer Systems with the required applications

Say



- Let's take a quick recap of the basic computer parts.
- Discuss 'Basic Parts of Computer' and 'Basic Parts of a Keyboard' with the class as given in the Participant Handbook.

Explain

- Explain all the parts of the computer and the keyboard by demonstrating on the real system.

Ask

- Do you know about internet?
- Have you ever used internet?
- Why do you think internet is useful?
- What was the last task you performed on internet?

Say



- Let's look at some basic internet terms.
- Discuss 'Basic Internet Terms' with the participants as given in the Participant Handbook.

Summarize

- Ask the participants what they have learnt from this exercise/ activity.
- Ask if they have any questions related to what they have talked about so far.
- Close the discussion by summarizing the importance of computer and internet for entrepreneurs.

Practical

- Conduct a practical session.
- Ask the participants to assemble in the computer lab.
- Give some hands on practice exercises.

Do

- Group the participants for the activity depending on the batch size and the number of computer systems available in the lab.
- Explain the purpose and duration of the activity.
- Ensure the participants complete the practical exercises assigned.

UNIT 8.2.2: MS Office and Email: About MS Office

Objectives

At the end of this unit, participants will be able to:

- Discuss the main applications of MS Office
- Discuss the benefits of Microsoft Outlook

Resources to be used

- Participant Handbook
- Computer Systems with MS Office

Ask

- What is the most frequent activity that you do on the computer?
- Do you know how to make presentations on the computer?

Say

- Give a brief introduction of MS Office as given in the Participant Handbook.
- Discuss the most popular office products. Explain in brief their application, benefits and working.
- Microsoft Word is a word processing program that allows for the creation of documents. The program is equipped with templates for quick formatting. There are also features that allow you to add graphics, tables, etc.
- Microsoft Excel is a tool for accounting and managing large sets of data. It can also simplify analysing data. It is also used to create charts based from data, and perform complex calculations. A Cell is an individual data box which will have a corresponding Column and Row heading. This gives the cell a name, referred to as the Cell Reference. There can be multiple pages in each workbook. Each page, or sheet, is called a Worksheet. When you open a new Excel file, it automatically starts you with three worksheets, but you can add more.

Explain

- Explain the working and frequently used features of Office on a real system.

Ask

- What do you know about e-mails?
- Do you have an email id?
- How often do you check your e-mails

Say

- Communication is vital for every business. The fastest and the safest way to communicate these days are through emails. MS Outlook helps to manage your emails in a better way and also offers a host of other benefits

Do 

- Ask the participants to assemble in the computer lab.
- Explain the working of Outlook on a real system.

Demonstrate

- Demonstrate how to create email id.
- Demonstrate how to write new mails, send mails.
- Demonstrate how to use MS Office application to create a letter and send it as attachment in an email.
- Demonstrate how to use other MS Office applications.

Practical

- Give some hands on practice exercises
- Group the participants for the activity depending on the batch size and the number of computer systems available in the lab.
- Explain the purpose and duration of the activity.

Summarize

- Ask the participants what they have learnt from this exercise/ activity.
- Ask if they have any questions related to what they have talked about so far.

UNIT 8.2.3: E-Commerce

Objectives

At the end of this unit, participants will be able to:

- Identify different types of e-commerce
- List the benefits of e-commerce for retailers and customers
- Discuss Digital India campaign will help boost e-commerce in India
- Describe how you will sell a product or service on an e-commerce platform

Resources to be used

- Computer System with internet connection
- Participant Handbook

Ask

- How many of you have done shopping online?
- Can you name at least five shopping websites?
- What is the product that you most frequently buy online?
- Why do you do shopping online instead of going to the market?

Say

- Give a brief introduction of “What is E-commerce”. Refer to the Participant Handbook.
- E- Commerce emerged in the early 1990s, and its use has increased at a rapid rate. Today, many companies sell their products online. Everything from food, clothes, entertainment, furniture and many other items can be purchased online.

Ask

- What other types of transactions have you performed on the internet other than buying products?

Say

- Give examples of e-commerce activities from Participant Handbook.

Team Activity

E-commerce examples

- Instruct the participants to list some of the payment gateways that they have used for e-commerce activities.
- Give them 5 minutes to make this list.
- Discuss payment gateways and transaction through payment gateways.
- Conclude the discussion by mentioning how important e-commerce has become in our day to day transactions.

Say

- E-commerce activities can be classified based on the types of participants in the transaction.
- Discuss “Types of E-commerce” from the Participant Handbook.

Do

- Discuss all types of E-commerce by giving examples and names of some popular websites which use them.
- Make the discussion interactive by asking the class to share some popular e-commerce sites of each type.

Say

- E-commerce activities bring a host of benefits for both, retailers and customers.
- Discuss benefits of E-commerce from the Participant Handbook.

Explain

- The majority of the population that uses E-commerce activities lives in tier-1 and tier-2 cities. To encourage the use of digital money in tier-3 and 4 areas, PM Mr. Modi launched the “Digital India Campaign”.
- Discuss “Digital India Campaign” from the Participant Handbook.
- By Digital India project the government will deliver services via mobile connectivity and in doing so, is expected to bring the internet and broadband to remote corners of the country. This connectivity will in turn enhance e-commerce activities also. Furthermore, the Indian Government is also modernizing India Post and aims to develop it as a distribution channel for e-commerce related services.

Say

- Now let us discuss how to sell a product using E-commerce.
- Every product has to be sold on a platform on the internet. Think of it as a shop that you have to sell your product. Now this shop can be your own or shared or rented. If the shop is your own or rented there will be only your products in that shop. If the shop is shared, there will be products of multiple sellers in that shop. A common example is a departmental store which has products from multiple brands in the shop.
- Similarly, in E-commerce the shop is the website where your products are displayed. If it is your own website it will exclusively showcase your products. In this case the cost that you will incur will be:
 - Developing the website
 - Hosting the website
 - Maintenance of the website
- If you rent a website it will also showcase your own products but the development, hosting and maintenance parts goes to the owner. This saves time and the cost to manage these activities.
- Smaller companies usually go for renting a website and the bigger ones develop their own website.
- The concept of shared platforms has become very popular in recent times. In this platform the sellers have to register and then they can sell their goods on a common platform. Among the most popular of these are Amazon, Myntra, Flipkart, etc.

Role Play

- Tell the participants to choose a product or service that they want to sell online.
- Tell them to write a brief note explaining how they will use existing e-commerce platforms, or create a new e-commerce platform to sell their product or service.

Ask

- How much money are you carrying in your wallet?
- Do you have a credit/debit card?
- How do you make payments while doing online shopping?

Say



- Demonetization has made carrying cash in the wallet very difficult. People either shop through cards or some other form of digital money.
- So what do you think is digital money?
- In this form the money is both paid and received digitally. There is no hard cash involved. It is an instant and convenient way to make payments.
- There are various types of digital payments. Let us discuss some of them in brief here.
- The first one is the most commonly used system i.e. the cards. Debit card, credit card, prepaid card, all fall under this category.
- Then is the e-wallet or the mobile wallet. This has become the most used form of digital money after demonetization. Examples are Paytm, state bank buddy, Free charge, etc.
- Many other forms of digital money are also coming up in market like mobile apps, Aadhar card based payment, etc.

Do



- Demonstrate how to make and receive payments through digital models like Paytm and state bank buddy.

Ask

- Why do you think people have started using digital money instead of hard cash? Is demonetization the only reason?

Say



- Digital money gives a lot of advantages over the conventional hard cash. Some of them are:
- Digital payments are easy and convenient. You do not need to take loads of cash with you, a mobile phone or a card will suffice.
- With digital payment modes, you can pay from anywhere anytime.
- Digital payments have less risk.

Summarize

- Ask the participants what they have learnt from this exercise/ activity.
- Ask if they have any questions related to what they have talked about so far.
- Close the discussion by summarizing the importance of e-commerce and digital money.

UNIT 8.3: Money Matters

Key Learning Outcomes



At the end of this unit, participants will be able to:

- Discuss the importance of saving money
- Discuss the benefits of saving money
- Discuss the main types of bank accounts
- Describe the process of opening a bank account
- Differentiate between fixed and variable costs
- Describe the main types of investment options
- Describe the different types of insurance products
- Describe the different types of taxes
- Discuss the uses of online banking
- Discuss the main types of electronic funds transfer

UNIT 8.3.1: Personal Finance – Why to Save?

Objectives

At the end of this unit, participants will be able to:

- Discuss the importance of saving money
- Discuss the benefits of saving money

Resources to be used

- Participant Handbook

Ask

- How many of you save money?
- Why do you feel the need to save it?
- Do you plan your savings?
- Where do you keep the money you save?
- How do you use the money that you have saved?

Example

- Let's look at these two examples:

Example 1:

Suhani works in a good company and earns Rs.30,000 month. She always saves 5000 per month and keeps it aside as a personal saving. She keeps the money at home and has saved quite a lot. One day her mother has a medical emergency and has to be taken to the hospital. Her family is worried about the amount they have to spend for the treatment. It will cost them at least 40,000.

Suhani says tells her family not to worry and that she has about 50,000, which she has saved over the months.

Example 2:

Jasmeet works in the same company and earns the same as Suhani. She is very fond of shopping and spends most of her money on buying new clothes. At the end of the month, she is always asking her father for money as her pay is finished.

Ask

- Who do you identify with –Suhani or Jasmeet?
- How do you think Suhani manages to save money which Jasmeet is unable to do?

Say

- We should always set aside some and save some money from our monthly pay. The future is unpredictable. Saving money not only gives you a sense of financial security but it can be used in case of emergencies.
- Discuss “Importance of Saving” with the participants as given in the Participant Handbook.

Ask

- What are the benefits of saving money?
- What does being financially independent mean to you?

Say



- Discuss “Benefits of Saving” with the participants as given in the Participant Handbook.
- Now let us continue with Suhani's story. Suhani has told her family not to worry and that she has about 50,000, which she has saved over the months. The family is happy about Suhani's decision of saving money, which will be of great help for them now.
- Suhani is going to the hospital today to pay the first installment for the treatment. Suddenly finds only 35,000 in her cash box when she counts and does not remember using it. She has not kept any record and now she is upset.

Ask

- Was it a good decision by Suhani to save a part of her earnings every month?
- Was it a wise decision to keep all her savings as cash in a cash box?
- Could she have managed to save money in a better and more effective manner?
- Do you want to learn how to save money and use it effectively?

Say



- Let's learn personal saving with the help of a group activity.

Team Activity

Personal Finance- Why to save

- This activity has two parts:

PART 1

WAYS TO SAVE MONEY

You are earning 30,000/- per month. You have recently changed your job and have to move to a metropolitan city. You are now living as a paying guest paying 10,000/- per month. Your other estimated expenditures like travel, food, recreation would be around Rs. 17, 000 per month.

Make a list of different ways to save money.

PART 2

HOW WILL YOU USE THE MONEY

- After a year how much have you been able to save?
- How will you use the money that you have saved?

Do



- Divide the class into groups of four.
- Instruct the participants to think and prepare a list of the various ways they can save money.
- Give the participants 10 minutes to prepare the list.
- Once done, instruct them to think of how they could use the money they have saved.
- Give the participants 10 minutes to prepare the list.
- Keep a check on time. Tell the group to wind up quickly if they go **beyond** the given time limit.

Activity De-brief

- What were the different ways you could save money?
- How much money were you able to save?
- How will you use the money you have saved in one year?

Say

- Discuss the importance of personal finance and why it is important to save money.

Summarize

You can summarize the session by discussing:

- The importance of saving money.
- Ways to save money.
- How the money saved can be used for different purposes.

UNIT 8.3.2: Types of Bank Accounts, Opening a Bank Account

Objectives

At the end of this unit, participants will be able to:

- Discuss the main types of bank accounts
- Describe the process of opening a bank account

Resources to be used

- Account opening sample forms
- Participant Handbook

Ask

- How many of you save money?
- Where do you keep the money you save?
- How many of you have a bank account?
- What type of account do you have?

Example

- Let's look at the given example:

Reena is in the third year of college but in the evening she gives tuitions for children living in her colony. She earns 15,000/- per month. As her students stay in different parts of the city, she has to walk a lot. To save time, she decides to buy a second hand scooter for herself. But she has to save money for it. Her class mate advises her to open a recurring deposit account in the bank. She goes to the bank close to her home. The personal manager gives her some forms to fill. She is confused as she has never done this before. Her elder sister has an account in the same bank. She asks for help from her sister. She goes to the bank the next day with her sister. The personal banker gives her a list of documents that she will need to submit with the form for opening an account. The banker advises her to open a 6 months recurring deposit.

Ask

- Do you try to save money monthly but have to spend it on unforeseen expenditure?
- Have you ever thought of depositing your savings in a bank?

Say

- Before opening a bank account, you need to know the types of accounts we have in India.
- Discuss “Types of Bank Accounts” with the participants as given in the Participant Handbook.

Ask

- Can someone say what the different types of bank accounts are?

Say

- Let's learn about the different types of bank accounts through an activity.

Team Activity

- Divide the class in four groups.
- Label the groups as savings account, current account, recurring account and fixed deposit.
- On a chart paper, ask them to write the key points of their account.

Activity De-brief

- Ask each group to present the key points of their account.

Say

- Now that you know about the four different types of accounts, let's learn how to open a bank account.
- Discuss "Opening a Bank Account" with the participants as given in the Participant Handbook.
- Discuss "Tips" that the participants should keep in mind while opening a bank account as given in the Participant Handbook.

Ask

- What are the main documents required for opening a bank account?
- What are some important points to ask the bank personnel while opening an account?

Say

- Mention officially valid KYC documents (refer to the Participant Handbook)
- Now, let's understand the procedure of opening a bank account through an activity.

Team Activity

- Opening a Bank Account
- This activity is done in groups.
- Divide the class in groups of four or six.

PART 1

FILLING A BANK ACCOUNT OPENING FORM

- You have to fill a bank opening form.
- You can refer to the section "Opening a Bank Account" of your Handbook for reference.
- List all the steps that you will be required to fill in the form.
- List the documents that you needs for filling the form.
- Now fill in the form.

Activity De-brief

- How did you design the form?
- What all details did you fill in the form?
- What were your KYC documents?
- How would this activity help you in future?

Do

- Instruct the participants to read the section “Opening a Bank Account’ of the Participant Handbook.
- Give each group one sample account opening form.
- Give the participants 5 minutes to read the form.
- Give them 15 minutes to fill it.
- Assist them by explaining each category and how to fill it.
- Keep a check on time.
- Tell the group to wind up quickly if they go beyond the given time limit.

Summarize

Note:

- You can summarize the unit through a role play.
 - A person wanting to open an account in the bank.
 - What is the procedure that he will go through?
 - Discuss the key points of different types of bank accounts.
 - How to select the type of account
 - How to fill the account opening form.
- A sample account opening form is given in the following page for reference. Use it for the activity in the class.
- **Sample Bank Account Opening form.**

XXX Bank

Photograph

SAVING BANK ACCOUNT OPENING FORM

Account No.:

Date:

Name of the Branch	
Village/Town	
Sub District / Block Name	
District	
State	
SSA Code / Ward No.	
Village Code / Town Code	Name of Village / Town

Applicant Details:

Full Name Mr./Mrs./Ms.	First	Middle	Last Name
Marital Status			
Name of Spouse/Father			
Name of Mother			
Address			
Pin Code			
Tel No. Mobile			Date of Birth
Aadhaar No.			Pan No.
MNREGA Job Card No.			
Occupation/Profession			
Annual Income			
No. of Dependents			

Detail of Assets	Owing House: Y/N Y/N No of Animals:	Owing Farm: Any Other :		
Existing Bank A/C. of family members/Household	Y/N	If yes, No. of A/C _____		
Kisan Credit Card	Whether Eligible	Y/N		
I request you to issue me a Rupay card				
I also understand that I am eligible for an Overdraft after satisfactory operation of my account after 6 months of opening my account for meeting my emergency/family needs subject to the condition that only one member for the household will be eligible for overdraft facility. I shall abide by the terms and conditions stipulated by the Bank in this regard.				
Declarations:				
I hereby apply for of a Bank Account. I declare that the information provide by me in this application form Is true and correct. The terms and conditions applicable have been read and explained to me and have understood the same. I shall abide by all terms and conditions as may be in force from time and time. I declare that I have not availed any Overdraft or Credit facility from any other bank.				
Place: _____				
Date : _____		Signature/LTI Applicant _____		
Nomination:				
I want to nominate as under				
Name of Nominee	Relationship	Age	Date of Birth in case of minor	Person authorized in case to received the amount of deposit on behalf of the nominee in the event of my/minor(s) Death.
Place: _____				
Date: _____				Signature/LTI of Applicant _____
Witness (es)*				
1. _____				
2. _____				
*Witness is require only for thumb Impression and not for signature _____				

UNIT 8.3.3: Costs: Fixed vs. Variables: What are Fixed and Variable Costs?

Objectives

At the end of this unit, participants will be able to:

- Differentiate between fixed and variable costs

Resources to be used

- Participant Handbook
- Blank sheets of paper
- Pens

Ask

- What is cost?
- Will a telephone bill fall under the category of a fixed or variable cost?

Say

- Discuss: Fixed and Variable cost with examples. Let us do a small activity.

Team Activity

Identify the type of cost

1. Rent
2. Telephone bill
3. Electricity bill
4. Machinery
5. Insurance
6. Office supplies/ Raw materials
7. Employee salaries
8. Commission percentage given to sales person for every unit sold
9. Credit card fees
10. Vendor bills

Do

- Divide the class into two groups. Read out the list of costs given in the activity.
- Read out each item from the cost list and ask the groups in turns to identify whether it is a fixed or variable cost.

Say

- We saw that your utility bills like rent, electricity, telephone etc. are all fixed costs because you have to pay it every month.
- Variable costs are an expense which varies with production output or volume. For example commission, raw material etc.
- Discuss “Cost: Fixed vs. variables” with the participants as given in the Participant Handbook.
- Illustrate the relation between the costs with a graph.

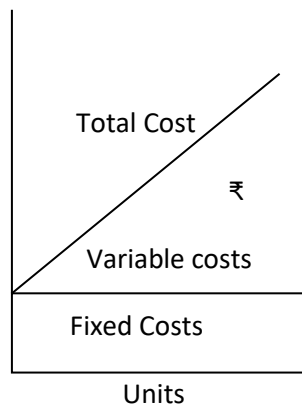

- Let's learn the difference between fixed and variable cost with the help of an activity.

Team Activity

Fixed vs. Variable Costs

- This is a group activity.
 - You want to start your own entrepreneur business.
 - State the type of business you want to start.
 - List down all the cost or requirements for your business.
 - How will you differentiate between the fixed and variable cost.

Activity De-brief

- What is the total cost of your business?
- What are the fixed costs?
- What are the variable costs?
- How did you differentiate between the fixed and variable costs?

Do

- Instruct the participants that this is group work.
- Divide the class into small groups of 4 or 6.
- Give each group a sheet of paper.
- Tell the participants that they have to start their own entrepreneur business.
- Ask them the type of business they want to start.
- Instruct them to differentiate between the fixed and the variable costs of the business they want to start.
- Give the participants 15 minutes to discuss and write.
- Keep a check on time. Tell the group to wind up quickly if they go beyond the given time limit.

Summarize

- Note: You can summarize the unit either by having a role play between a consultant and a budding entrepreneur explaining the differences between fixed and variable costs or by discussing the key points of the unit.

Notes for Facilitation



- Answers for the activity - Identify the type of cost
- | | |
|--|------------|
| 1. Rent | (Fixed) |
| 2. Telephone bill | (Fixed) |
| 3. Electricity bill | (Fixed) |
| 4. Machinery | (Fixed) |
| 5. Insurance | (Fixed) |
| 6. Office supplies/ Raw materials | (Variable) |
| 7. Employee salaries | (Fixed) |
| 8. Commission percentage given to sales person for every unit sold | (Variable) |
| 9. Credit card fees | (Variable) |
| 10. Vendor bills | (Variable) |

UNIT 8.3.4: Investments, Insurance and Taxes

Objectives

At the end of this unit, participants will be able to:

- Describe the main types of investment options
- Describe the different types of insurance products
- Describe the different types of taxes

Resources to be used

- Participant Handbook

Ask

- Ask the participants- “What do you see first thing in when you get your mobile bill? Apart from the amount and due date do you have a look at the taxes you are being billed for?”
- Why do you think people get their cars insured or have a medical insurance?
- You have saved money and want to invest it, how would you decide what is the best investment for your money?

Example

- Let's have a look at a few scenarios.

Ranbir has sold his house and deposited the money in his bank. His Chartered Accountant tells him that he will have to re-invest the money otherwise he will have to pay capital tax. What is capital tax and how is it different from income tax?

Jasmeet and Anup are blessed with a baby girl. They decide to have an insurance policy that will mature when their daughter is ready to higher education.

Shivani is working in a corporate office and getting good pay. She will have to pay income tax so she decides to invest her money in tax saving schemes. She goes to the bank manager to discuss the best products in which she can invest.

Say

- Discuss the Investment, Insurance and Taxes as given in the Participant Handbook.

Ask

- How do investments, insurances and taxes differ from each other?

Say

- Let's learn the differences between the three by having an activity.

Say

- We will have a quiz today.

Team

- The activity is a quiz.

Do

- Divide the class into groups of three and give a name to each group
- Explain the rules of the quiz. For each correct answer the group gets 1 mark. If the group is unable to answer the question is rolled over to the next group.
- Explain the purpose and duration of the activity.
- On the blackboard write the names of the groups.
- Ask the questions of the quiz.
- Keep a score for the groups.
- Set guidelines pertaining to discipline and expected tasks.

Summarize

- Summarize the unit by discussing the key points and answering question

Notes for Facilitation**Questions for the quiz**

1. What are bonds?
Bonds are instruments used by public and private companies to raise large sums of money.
2. Who issues the bonds?
Private and public companies issue the bonds.
3. Why are bonds issued?
To raise large amount of money as it cannot be borrowed from the bank.
4. Who is the buyer of stocks and equities?
The general public is the buyer.
5. What types of scheme is the Sukanya Samriddhi Scheme?
Small Saving Scheme
6. What is the difference between mutual and hedge funds?
Mutual funds are professionally managed financial instruments that invest the money in different securities on behalf of investors. Hedge funds invest in both financial derivatives and/or publicly traded securities.
7. Why is a loan taken from the bank to purchase real estate?
To lease or sell to make profit on appreciated property price.
8. Name the two types of insurances?
Life Insurance and Non-life or general insurance
9. Which insurance product offers financial protection for 15-20 years?
Term Insurance
10. What is the benefit of taking an endowment policy?
It offers the dual benefit of investment and insurance.
11. Mr. Das gets monthly return on one of his insurance policies. Name the policy?
Money Back Life Insurance
12. What are the two benefits of a Whole Life Insurance?
It offers the dual benefit of investment and insurance

13. Which policy covers loss or damage of goods during transit?

Marine Insurance

14. After what duration is the income tax levied?

One financial year

15. What is long term capital gain tax?

It is the tax payable for investments held for more than 36 months.

16. Name the tax that is added while buying shares?

Securities Transaction Tax

17. What is the source of corporate tax?

The revenue earned by a company.

18. Name the tax whose amount is decided by the state?

VAT or Value Added Tax

19. You have bought a T.V. What tax will you pay?

Sales Tax

20. What is the difference between custom duty and OCTROI?

Custom duty is the charges payable when importing or purchasing goods from another country. OCTROI is levied on goods that cross borders within India.

UNIT 8.3.5: Online Banking, NEFT, RTGS, etc.

Objectives

At the end of this unit, participants will be able to:

- Discuss the uses of online banking
- Discuss the main types of electronic funds transfer

Resources to be used

- Participant Handbook
- Computer System with internet connection
- Debit card

Ask

- When was the last time you visited a bank?
- How do you pay your bill for electricity and telephone?
- Have you ever tried to transfer money from one bank account to another bank account using the online banking facility?

Say

- Most of us lead a busy life. Time has become more important than money. In this busy schedule no one has time to stand in bank queues. That's where Online Banking comes in. Online banking or internet banking means accessing your bank account and carrying out financial transactions through the internet.
- Discuss "What is online banking?" from the Participant Handbook.
- There are various advantages of online banking:
 - It saves time, as you need to visit the branch. .
 - You can conduct your banking transactions safely and securely without leaving the comfort of your home.
 - Online Banking also gives you round the clock access.
 - Online Banking makes it possible for you to pay your bills electronically.

Do

- Show them how they can use the internet banking.
- Use the computer system and show the demo videos on how to use internet banking provided on most banking sites. The computer system.
- Tell the class the various features of online banking:
 - Through their website set-up your online account.
 - Choose a secure username and password.
 - Set-up your contact information.
 - Once your information is verified, you are good to go.
 - Once you enter the portal explore all the features and learn your way through the portal.
 - Discuss about maintaining the security of the online account.

Say

- One of the biggest advantage that online banking offers, as discussed earlier, is transferring money from one account to another. This transaction is called electronic funds transfer. Electronic transfers are processed immediately with the transferred amount being deducted from one account and credited to the other in real time, thus saving time and effort involved in physically transferring a sum of money.
- Discuss “Electronic Funds Transfer” from the Participant Handbook.

Do

- Discuss how to transfer money from one account to another using online banking (NEFT/ RTGS, etc.).
- Illustrate with an example.

Summarize

- Close the discussion by summarizing the about online banking.
- Ask the participants if they have any questions related to what they have talked about so far.

UNIT 8.4: Preparing for Employment & Self Employment

Key Learning Outcomes



At the end of this unit, participants will be able to:

- Discuss the steps to follow to prepare for an interview
- Discuss the steps to create an effective Resume
- Discuss the most frequently asked interview questions
- Discuss how to answer the most frequently asked interview questions
- Identify basic workplace terminology

UNIT 8.4.1: Interview Preparation: How to Prepare for an Interview?

Objectives

At the end of this unit, participants will be able to:

- Discuss the steps to follow to prepare for an interview

Resources to be used

- Participant Handbook

Ask

- Have you ever attended an interview?
- How did you prepare before going for an interview?

Say

- An interview is a conversation between two or more people (the interviewer(s) and interviewee) where questions are asked by the interviewer to obtain information from the interviewee.
- It provides the employer with an opportunity to gather sufficient information about a candidate and help them select the ideal candidate.
- It also provides the interviewee with an opportunity to present their true potential to the employer, build confidence and help make a decision about the job by asking questions regarding designation, salary, perks, benefits, promotions, transfers, etc.
- Let's do an activity to understand how to prepare for interviews better.

Activity 1

- Introducing Yourself

Do

- Select a participant and ask him/her to answer the following questions: “What can you tell me about yourself.”
- Give the participant at least one minute to speak.
- Once he/she is done, ask the rest of the participant what they gathered about the participant who was providing information.
- Now repeat the exercise with five other participants.

Ask

- What information you should include when you are describing or introducing yourself in an interview?
- What information you should not include when you are describing or introducing yourself in an interview?

Say



- Tell the participants that when an interviewer asks you to say something about yourself, he/she is not asking you to present your life history.
- Introduction should be short and crisp, and should present you in a positive light. It should include the following points:
 - Any work experience that you might have
 - A brief summary of your educational qualifications
 - Your strengths and achievements
 - Any special projects that you might have been part of
- The following topics should be avoided during an introduction:
 - Detailed description of your family (unless you are specifically asked to do so)
 - Too much information about your weaknesses
 - Information that is not true

Do



- Congratulate each participant for sharing their points.
- Ask the audience to applaud for them.
- Ask de-brief questions to cull out the information from each group.
- Keep a check on time.

Activity 2

- Planning the right attire

Do



- Describe 2 individuals to the participants. One is wearing a casual t-shirt, jeans, and slippers. He has not combed his hair and neither has he trimmed or shaved his beard. The other individual is dressed formally with a shirt and pant, and is well-groomed. He has also worn formal shoes and a belt. Ask the participants which person would they prefer to hire in their organization and why?

Summarize

- Close the discussion by discussing 'how to prepare for an interview' as discussed in the Participant Handbook.
- You can add the following points to it:
- Tell the participants to create a positive and good impression in an interview. It is important for them to prepare for an interview beforehand.

- The interviewer analyses not only your technical knowledge in relation to the job, but also whether or not you are a fit for the organization.
- Every employer looks at the whole package and not just one or two things in isolation. Therefore, the way you dress and the way you present yourself is also important along with your skills and talents.
- The participants will get only one chance to create a good first impression.

UNIT 8.4.2: Preparing an Effective Resume: How to Create an Effective Resume?

Objectives

At the end of this unit, participants will be able to:

- Discuss the steps to create an effective Resume

Resources to be used

- Participant Handbook
- Blank papers
- Pens

Ask

- When preparing for an interview, what are the most important things that you need to do?
- What documents do you carry with you, when you go for an interview?
- What is a resume?
- Why do you need a resume?

Say

- Resume is not just a sheet of paper with your qualifications printed on it.
- It is a selling tool that will help the employer to see how and what you can contribute for company.
- Talk about the steps involved in creating an effective/attractive resumes discussed in the Participant Handbook.
- Now let's prepare a resume to understand the process in a better way.

Do

- This is an individual activity.
- Give the details of the activity.
- Instruct them to read the activity carefully.
- The participant is expected to make an attractive resume based on the information provided.
- Give the class 25-30 minutes to study the case and create a resume.
- At the end of 30 minutes, the participants should exchange the resume with the person sitting next to him or her.
- Every participant will evaluate the resume prepared with their fellow participants.

Say

- Do you think the candidate should apply for the job posting described in the advertisement?
- We have already discussed the steps involved in creating an effective/attractive resumes.
- Now let's prepare a resume for the candidate details given in the activity.

Activity



Case Study Analysis

- In the first section of the activity, you are being given the information about a candidate who is applying for a particular job.
- In the second section, you are being given the detailed description of the job posting. Create a resume for the candidate to apply for the job posting.
- Use the information that has been provided about the candidate to create this resume.

Candidate Details

Nipesh Singla was born on 20th April, 1988 in Chandigarh, India. He currently resides at 1XX7, Sector XX D, Chandigarh –160018. His mobile number is 988XXXXX01, and e-mail address is nxxxxxxxla@gmail.com. Nipesh attended middle and senior school at Government Boys Senior Secondary School, Sector 15, Chandigarh. He has been a very talented boy since school. He was fond of painting and watching old Hindi movies. As part of a school charity program, he volunteered at the children's hospital during his senior years. In July 2007, he joined Westwood School of Hotel Management, Zirakpur to pursue a diploma course in Hotel Management and Catering. After completing this course, he joined XYZ Group of Hotels as a Housekeeping intern in June 2010 for six months. In this role, he was responsible for cleanliness and maintenance of one floor in the hotel. Taking advantage of his strong interpersonal skills, he also got opportunities to make housekeeping arrangements for corporate meetings. While pursuing education, he gained working knowledge of Microsoft Word, Excel, Access and PowerPoint.

Nipesh is detail-oriented, flexible and adaptable. He has successfully worked with a diverse work force. He gelled well with his peers, both in college and during his internship. After completing the internship, his objective has been to find a job opportunity where he can use his skills and experience. Backed by experience, he is confident about his skills as housekeeping assistant.

Job Posting

*Do you see yourself as a HOUSEKEEPING SUPERVISOR?

What's your passion? Whether you're into cricket, reading or hiking, at IHG we are interested in YOU. At IHG, we employ people who apply the same amount of care and passion to their jobs as they do in their hobbies - people who put our guests at the heart of everything they do. And we're looking for more people like this to join our friendly and professional team.

THE LOCATION:

At the moment, we are looking for HOUSEKEEPING SUPERVISOR to join our youthful and dynamic team at Holiday Inn Amritsar, Ranjit Avenue in Amritsar, Punjab (India). Holiday Inn Amritsar is ideally located in Amritsar's commercial district on Ranjit Avenue with the world famous Golden Temple located only a short distance away. Sparkling chandeliers mark an incomparable arrival experience as you escape to the welcoming environment that is, Holiday Inn Amritsar. The fresh international brand to celebrate and explore Amritsar.

Salary: Negotiable

Industry: Travel / Hotels / Restaurants / Airlines / Railways

Functional Area: Hotels , Restaurants

Role Category: Housekeeping

Role: Housekeeping Executive/Assistant.

Desired Candidate Profile

Friendly, pleasant personality, Service - oriented.

You should ideally be Graduate/ Diploma holder in HM and at least 2 years of experience as a supervisor in good brand with good communication skills, English is a must.

In return we'll give you a competitive financial and benefits package. Hotel discounts worldwide are available as well as access to wide variety of discount schemes and the chance to work with a great team of people.

Most importantly, we'll give you the room to be yourself.

*Please get in touch and tell us how you could bring your individual skills to IHG.

Education-
 UG: Any Graduate/ Diploma holder
 PG: Post Graduation Not Required

Say

- Now, let's share the resume with the fellow participant sitting next to you and evaluate each other's effort.

Do

- Congratulate each participant for making their first attempt towards creating an effective resume.
- As a follow up activity, you can suggest them to prepare their own resume and show it to you the next day.

Summarize

- Close the discussion by showing some effective resume samples to the candidates.
- Ask the participants what they have learnt from this activity.
- Ask if they have any questions related to what they have talked about so far.

Notes for Facilitation

- Keep printed copies of the activity ready for the session.
- Put down the suggested format of the resume on the board while explaining the steps in preparing a resume.
- Do check the participants' resume and suggest necessary changes.
- Suggested example for the case presented:

Nipesh Singla
 #1XX7, Sector XX-D
 Chandigarh-160018
 Mobile No: 91-988XXXXX01
 E-mail: nxxxxxxxxla@gmail.com

Objective: Seeking an opportunity to use my interpersonal skills and experience to contribute to your company's growth, profitability and objectives.

Professional strengths:

Proficient in housekeeping

- Experienced in and capable of working with a diverse work force
- Team player and friendly in nature
- Successful working in a multi-cultural environment
- Detail oriented, flexible, and adaptable
- Knowledge of Microsoft Word, Excel, Access and PowerPoint

Educational background:

- Diploma in Hotel Management and Catering, Westwood School of Hotel Management, Zirakpur
- High School, Government Boys Senior Secondary School, Sector 15, Chandigarh

Professional internships:

- Housekeeping Intern, XYZ Group of Hotels, New Delhi (June 2010 – August 2010)
- Responsible for cleanliness and maintenance of one floor in the hotel.
- Got opportunities to make housekeeping arrangements for corporate meetings.

Volunteer Work:

Student volunteer at children's hospital in Chandigarh.

Nipesh Singla

UNIT 8.4.3: Interview FAQs

Objectives

At the end of this unit, participants will be able to:

- Discuss the most frequently asked interview questions
- Discuss how to answer the most frequently asked interview questions

Resources to be used

- Participant Handbook

Say

- Tell the participants you will provide them with interview situation and questions and they have to try to answer them.
- Tell them you will also explain the different ways to approach these questions.

Do

- Divide the class in pairs and ask the participants to perform a role play.
- One partner will play the role of the interviewer while the other will play the role of the interviewee.
- Tell them the interviewer can start the interview by asking the interviewee to introduce himself/herself.
- Call all the pairs one by one in front of the class to enact the role play.
- Follow the same pattern for all other situations.
- Time allotted for each situation is 8-10 minutes.
- Congratulate each participant for giving their input.
- Ask the class to applaud each time a team has completed their role play.
- Keep a check on time.

Role Play

Conduct a role play for the situation given.

Situation 1

- The interviewer will start by asking the interviewee a few generic questions such as:
 - What is your name?
 - Tell me something about yourself?
 - Can you tell me something about your family?
- Then, the interviewer will bluntly ask the following questions:
 - How do you explain this huge time gap in your resume?
 - What is the reason for this?
 - Weren't you looking for a job or is it that no one selected you?

Say

De-brief:

- When you put information on your resume, you should be prepared to answer any questions about it.
- Be present and focused on the questions being asked to you.
- One way of tackling the blunt questions is to tell the interviewer you did not come across an opportunity where you were sufficiently satisfied with both the remuneration offered as well as the profile. Therefore, you waited for the right opportunity to come along while looking for an ideal job.

Role Play

Conduct a role play for the situation given.

Role Play – Situation 2

- The interviewer will start by asking the interviewee a few generic questions such as:
 - What is your name?
 - Tell me something about yourself?
 - Can you tell me something about your family?
- Then, at the end of the interview, ask the interviewee:
 - There are over 200 people who have applied for this job, some with excellent work experience. Why should I hire you?

Say

De-brief:

- There is nothing wrong with stating your strengths and achievements. However, do not come across as arrogant or too boastful.
- You need show the interviewee that you have unique skills or talents to contribute to the company. The interviewer needs to know how you stand apart from the rest of the crowd.
- Tell the interviewer you are looking forward to working with the company and that you are a hard-working individual.

Role Play

Conduct a role play for the situation given.

Role Play – Situation 3

- The interviewer will start by asking the interviewee a few generic questions such as:
 - What is your name?
 - Tell me something about yourself?
 - Can you tell me something about your family?
- Then, lean forward, clasp your hands on the table and in a soft voice ask the interviewee:
 - Did you ever experience any neglect or disregard from your previous office? In other words, did you ever suffer because your office or team displayed favoritism?

Say

De-brief:

- Keep this in mind: Do not criticize anyone during an interview.
- You are free to express your opinion; however, your language, answers, body language, and the tone of your voice should remain constructive and neutral.
- Since criticism will show you in negative light, you should keep your answers honest yet diplomatic.

Role Play

Conduct a role play for the situation given.

Role Play – Situation 4

- The interviewer will start by asking the interviewee a few generic questions such as:
 - What is your name?
 - Tell me something about yourself?
 - Can you tell me something about your family?
- Then very bluntly ask the interviewee:
 - How long do you plan to stay with this company if you are selected?
 - After the candidate responds, ask sarcastically:
 - Do you seriously mean that?

Say

De-brief:

- Don't provide unreal and idealistic answers.
- Your answers should be honest yet diplomatic. In a situation like this, the interviewer does not expect you to provide a specific timeline.
- You can say something like, "I would like to stay with the company as long as I can contribute constructively and develop as an employee, within the organization, professionally and financially."

Role Play

Conduct a role play for the situation given.

Role Play – Situation 5

- The interviewer will start by asking the interviewee a few generic questions such as:
 - What is your name?
 - Tell me something about yourself?
 - Can you tell me something about your family?
- Ask him/her how important he/she thinks it is to be punctual in the corporate world.
- After he/she answers, look up sternly at the interviewee and in a crisp voice, say:
 - You were late for this interview by 10 minutes. That surely does not seem to be in line with what you just said?

Say

De-brief:

- Politely apologize for being late.
- You can add something such as, "I assure you this is not a habit". All your future actions should be in line with this statement.
- Avoid giving any excuses.
- You might feel obligated to provide a justification for your tardiness, but the interviewer is not interested in that.
- Do not over apologize. Once this response is out of the way, turn your focus back to the interview.

Role Play

Conduct a role play for the situation given.

Role Play – Situation 6

- The interviewer will start by asking the interviewee a few generic questions such as:
 - What is your name?
 - Tell me something about yourself?
 - Can you tell me something about your family?
- After asking a few academic or job-related questions, ask the interviewee:
 - If you get this job, what salary package do you expect us to give you?

Say

De-brief:

- If there is no way for you to avoid this question, respond to the interviewer by providing a reasonable and well-thought out salary range.

Role Play

Conduct a role play for the situation given.

Role Play – Situation 7

- The interviewer will start by asking the interviewee a few generic questions such as:
 - What is your name?
 - Tell me something about yourself?
 - Can you tell me something about your family?
- Then, bringing the interview to a close, ask the interviewee:
 - Do you have any questions for me?

Say

De-brief:

- Ask relevant questions.
- Don't bombard the interviewer with questions.
- If you have questions about the result of the interview, you can limit your questions to 1 or 2. Keep them short and relevant like:
 - When will I be informed about the results of the interview?
 - What are the working hours?
 - Will the job require me to travel?

Explain

- Tell the participants to be prepared for answering different types of questions in an interview.
- Stay calm and focused, and take a moment to think about how you should respond. Always maintain a confident tone.
- Even if you don't intend to, your body language conveys your level of discomfort with a particular question. Try to keep your actions, tone, and gestures neutral.
- Maintain your composure while answering personal question.

Do

- Tell all the participants to form pairs again.
- Tell them to use the following list of frequently asked interview questions to conduct mock interviews.
- They will use all or some of these questions to conduct mock interviews with their partners.
- One partner will play the role of the interviewer while the other will play the role of the interviewee.
- After they are through asking and answering the questions, the roles will be reversed.
- The same list of questions will be used again.
- After each mock interview ask the interviewer to provide feedback and clear any doubts that may arise.
- Time allotted for each situation is 30-35 minutes.

Activity

Mock Interview Questions

Mock Interview Questions
Tell me something about your family.
What qualities would you look for in a Manager or a Supervisor?
Why did you apply for this job?
What do you know about this company?
How do you deal with criticism?
How do you plan to strike a good work-life balance?
Where do you see yourself five years from now?
Have you applied for jobs in other companies?
What kind of salary do you expect from this job?
Do you have any questions for me?

Summarize

- Close the discussion by discussing the questions in the both activities.
- Ask the participants what they have learned from this activity.
- Ask if they have any questions related to what they have talked about so far.

UNIT 8.4.4: Work Readiness – Terms and Terminology

Objectives

At the end of this unit, participants will be able to:

- Identify basic workplace terminology

Resources to be used

- Participant Handbook
- Chart papers
- Blank sheets of paper
- Pens

Ask

- What do you understand by workplace terminology?
- Are offer letter and contract of employment the same?

Say

- Let's start this unit with an activity.

Team Activity

Workplace terminology

- This is a group activity conducted in three parts.

Part 1

Sheila received a call from the recruiter of MND Company. Before she is recruited by the company, think of the recruitment process she will have to go through. Start from the telephone call to signing her letter of acceptance. Write down all the words that come to your mind.

Activity De-brief

- Have the participants read out the words they have written
- Encourage all the participants to participate in the activity

Do

- Divide the class into small groups of 4 or 6.
- Instruct the participants that they will be doing a brainstorming activity.
- Give them one chart paper each. Tell them to divide the chart in two parts.
- Instruct them that they have to use one half of the chart paper now. The other half will be used later.
- The participants have to write all the words that come to their mind related to the recruitment process.
- Give them 10 minutes to do the activity.

Say

- You all know quite a few words related to the terms used in the office.
- Let us talk about some new terms that have been missed out.
- Discuss “Work Readiness – Terms and Terminology” with the participants as given in the Participant Handbook.

Ask

- Why is it important to know the workplace terms?
- How do they help?
- Can the words be categorized further?

Say

- Let's now continue the activity.

Team Activity

Terms and Terminology

- This is again a group activity. The members of the group remain the same as in Activity 1.

Part 2

With the help of the new terms you have learned, make a flow chart of the hiring process of MND Company.

Part 2

With the help of the new terms you have learned, make a flow chart of the hiring process of MND Company.

Do

- Instruct the participants that they have to use the 2nd half of the same chart they had used before.
- Using the new terminology and the terms they had previously written on the chart, they have to make a flow chart of the hiring process of the MND Company.
- Give them 10 minutes for this activity.
- Keep a check on time. Tell the group to wind up quickly if they go beyond the given time limit.

Say

- Let's go ahead with the activity.

Team Activity

Terms and Terminology

- The activity continues with the same group members.

Part 3

Sheila now works for the MND Company. She is not aware of the company culture and policies. She goes to the HR Department to get her doubts clarified. Can you think of the terms for which she wants clarity? Make a list of those words.

Activity De-brief

- Ask the groups to share their list of words. Some of the words are benefits, comp. time, deduction, employee training, holidays, lay-off, leave, maternity leave, mentor, notice, paternity leave, and time sheet.

Do 

- Instruct the participants to identify the key terms an employee of a company should know. They can use the same chart paper for this activity.
- Give them 5 minutes for this activity.
- Keep a check on time. Tell the group to wind up quickly if they go beyond the given time limit.

Summarize

- Note: You can either summarize the key points of the unit or have a role play where an employee has just joined a company and the HR Manager explains the terms of employment.

UNIT 8.5: Understanding Entrepreneurship

Key Learning Outcomes



At the end of this unit, participants will be able to:

- Discuss the concept of entrepreneurship
- Discuss the importance of entrepreneurship
- Describe the characteristics of an entrepreneur
- Describe the different types of enterprises
- List the qualities of an effective leader
- Discuss the benefits of effective leadership
- List the traits of an effective team
- Discuss the importance of listening effectively
- Discuss how to listen effectively
- Discuss the importance of speaking effectively
- Discuss how to speak effectively
- Discuss how to solve problems
- List important problem solving traits
- Discuss ways to assess problem solving skills
- Discuss the importance of negotiation
- Discuss how to negotiate
- Discuss how to identify new business opportunities
- Discuss how to identify business opportunities within your business
- Explain the meaning of entrepreneur
- Describe the different types of entrepreneurs
- List the characteristics of entrepreneurs
- Recall entrepreneur success stories
- Discuss the entrepreneurial process
- Describe the entrepreneurship ecosystem
- Discuss the purpose of the Make in India campaign
- Discuss key schemes to promote entrepreneurs
- Discuss the relationship between entrepreneurship and risk appetite
- Discuss the relationship between entrepreneurship and resilience
- Describe the characteristics of a resilient entrepreneur
- Discuss how to deal with failure

UNIT 8.5.1: Concept Introduction (Characteristic of an Entrepreneur, types of firms/ types of enterprises)

Objectives

At the end of this unit, participants will be able to:

- Discuss the concept of entrepreneurship
- Discuss the importance of entrepreneurship
- Discuss the characteristics of an entrepreneur
- Describe the different types of enterprises

Resources to be used

- Participant Handbook

Say

- Let's start this session with some interesting questions about Indian entrepreneurs.

Team Activity

Quiz Questions

1. Who is the founder of Reliance Industries?
Dhirubhai Ambani
2. Who is the Chairman of Wipro Limited?
Azim Premji
3. Who launched e-commerce website Flipkart?
Sachin Bansal and Binny Bansal
4. Who is the founder of Paytm?
Vijay Shekhar Sharma
5. Who is CEO of OLA Cabs?
Bhavish Aggarwal
6. Who is the founder of Jugnoo?
Samar Singla (auto rickshaw aggregator)
7. Who is the founder of OYO Rooms?
Bhavish Aggarwal

Do

- Tell them that you will ask them few questions about a few entrepreneurs.
- Divide the class in to two groups.
- In turns ask the quiz questions to the groups.
- If the answer is incorrect pass the question to the other group.
- Share the answer if the groups are not able to answer.
- Congratulate the participants who answered correctly.

Ask

- What do you understand by entrepreneurs?
- What is the importance of entrepreneurship in today's scenario?
- What do you think are the characteristics of successful entrepreneurs?
- What are different types of enterprises that an entrepreneur in India can own and run?

Say

- Talk about entrepreneurs, importance of entrepreneurship, characteristics of successful entrepreneurs, and different types of enterprises in India as discussed in the Participant Handbook.
- Tell the participants, stories of successful Indian entrepreneurs- their struggles, the moments of heartbreak, the perseverance and triumph.
- Ask them if they know of any such entrepreneur.

Summarize

- Close the discussion by summarizing about the opportunities for entrepreneurs in India.

Notes for Facilitation

- Check out different Government schemes for small entrepreneurs. Share the information with the participants.
- You can tell them about the government websites like Start Up India, mudra.org.in etc.
- Discuss about various schemes and policies by the Government of India for entrepreneurs.

UNIT 8.5.2: Leadership and Teamwork

Objectives

At the end of this unit, participants will be able to:

- List the qualities of an effective leader
- Discuss the benefits of effective leadership
- List the traits of an effective team

Resources to be used

- Participant Handbook
- Blank sheets of paper
- Pens

Do

- Show the picture given below to the class.
- Ask them to quickly write on a piece of paper what comes to their mind after seeing the picture.
- Now ask them, “What do you understand from this picture?”
- Encourage participants to share their thoughts.

Say

- This picture depicts the qualities of a leader and the difference between a leader and a boss.
- A boss focuses on structure and inspires fear whereas a leader follows vision and generates enthusiasm.
- A boss blames employees for the breakdown whereas a leader fixes breakdowns.
- A boss depends on authority whereas a leader depends on goodwill.
- A boss says “I” and a leader says “We.”
- A boss drives employees whereas a leader coaches them.
- A boss takes credit whereas a leader gives credit.

Say

- Talk about leadership and leadership qualities for an entrepreneur as discussed in the Participant Handbook.

Ask

- Why is it important for a leader to be effective? How does it help the organization?

Say

- Let us discuss benefits of effective leadership as discussed in the Participant Handbook.
- “Out-of-the-box thinking” is one of the new leadership styles. It means thinking differently and from a new perspective.

Ask

- Do you consider yourself a team player?

Team Activity

- Long Chain
- This is a group activity.

Do



- Divide the class into 2 teams.
- Ask each team to create a chain using materials they have in class such as shoe laces, belts, paper, handkerchief, ribbons, etc.
- The team that creates the longest chain wins the game.
- Observe if the participants are interacting with their team or working in isolation.
- Share your observations with the class.

Say



De-brief:

- What did the winning team do differently?
- Who was responsible for the winning team's success?
- How does this activity explain the role of teamwork in entrepreneurial success?

Say



- Tell the class that both the teams performed well.
- Discuss that the objective of this activity was to open communication channels and how this has been achieved.
- The participants should aim to keep the communication channels open when interacting with their peers and team members.
- It will set the pace and enthusiasm required for all the ensuing teamwork activities.
- Talk about teamwork and importance of teamwork in entrepreneurial success as discussed in the Participant Handbook.

Summarize

- Close the discussion by summarizing about the importance of teamwork for employees.
- Teamwork helps in reducing stress for the employees.
- Teamwork helps employers in generating more number of solutions to a problem and developing improved communication amongst employees.
- Ask the participants what they have learned from these exercises.
- Ask if they have any questions related to what they have talked about so far.
- UNIT 9.5.3: Communication Skills: Listening & Speaking:

UNIT 8.5.3: Communication Skills: Listening & Speaking: The Importance of Listening Effectively

Objectives

At the end of this unit, participants will be able to:

- Discuss the importance of listening effectively
- Discuss how to listen effectively
- Discuss the importance of speaking effectively
- Discuss how to speak effectively

Resources to be used

- Participant Handbook

Activity 1

Activity – Chinese Whisper

Step 1: Form a circle.

Step 2: Start a whisper chain. Any one participant will whisper a message into his/her neighbor's ear. No one else must hear the message. The message can be serious or downright silly.

Step 3: The next person who first heard the message should whisper the message very quickly to the person sitting next to them.

Step 4: The game goes on until the last person says whatever they heard out loud and the first person reveals the real message.

Compare them and have a great laugh!

Ask

De-brief questions:

- Was the original message the same as the message that is communicated at the end of the game?
- Why do you think there was a difference in the messages?

Say

- No, the original message was not same at the end of game.
- The barriers to communication like language, disturbance and noise, poor listening skills, boredom, poor speaking skills, etc. are the potential reasons this happens.
- There are various aspects to communication. Speaking skills and listening skills are two major components to any communication. There is always some room for improvement in the way we communicate.
- It is important to accept the reality of miscommunication and work to minimize its negative impacts.

Say

- Communication is a two-way process where people exchange information or express their thoughts and feelings
- It involves effective speaking and effective listening.
- If I go to the store to get bread, I exchange money for the bread. I give something and get something in return. Communication takes place in the same manner. You have to provide and receive information for communication to take place.

Ask

- How often do you hear these statements?
 - “You're not listening to me!”
 - “Why don't you let me finish what I'm saying?”
 - “You just don't understand!”
- What do you think the other person is trying to convey to you through these sentences?
- We will not talk about the importance of listening effectively as discussed in the Participant Handbook.

Say

- Let's play a game to understand effective listening process better.

Do

- This is a class activity.
- The participants need to answer the questions they hear.
- Instruct them to listen carefully.
- You will read it at a stretch and if need be repeat it once more.
- Tell the participants to raise their hand if they know the answer to the question asked.
- Keep a check on time.

Activity

Riddles:

Is there any law against a man marrying his widow's sister?
If you went to bed at eight o'clock at night and set the clock's alarm to ring at nine o'clock, how many hours of sleep would you get?
Do they have a 26th of January in England?
If you had only one match and entered a dark room that had a kerosene lamp, oil heater, and a wood stove, what would you light first?
The Delhi Daredevils and the Chennai Super Kings play five IPL matches. Each wins three matches. No match was a tie or dispute. How is this possible?
There was an airplane crash. Every single person died, but two people survived. How is this possible?
If an airplane crashes on the border of two countries, would unidentified survivors be buried in the country they were travelling to or the country they were travelling from?
A man builds an ordinary house with four sides except that each side has a southern exposure. A bear comes to the door and rings the doorbell. What is the color of the bear?

Answers:

There's no law against a man marrying his widow's sister, but it would be the neatest trick in the book since to have a widow, the man would have to be dead.

You'd get one hour's sleep since alarm clocks do not know the difference between morning and night.

Oh, yes. They have a 26th of January in England. They also have a 27th, a 28th, and so on.

First of all, you would light the match.

Who said the Delhi Daredevils and the Chennai Super Kings were playing against each other in those games?

Every SINGLE person died, but those two were married.

You can't bury survivors under any law especially if they still have enough strength to object.

The bear that rang the doorbell would have to be a white bear. The only place you could build a house with four southern exposures is at the North Pole where every direction is in South.

Ask

De-brief question:

- What were the barriers that came into your way of listening?
- How can you overcome barriers to listening?

Say

- There is a difference between hearing and listening.
- If you don't listen properly, the message may be misunderstood.
- Be open-minded while listening to someone.
- It is important to listen effectively and carefully without making assumptions.

Activity3**Elevator Pitch:**

You are in the lift of a hotel and you bumped into your former client who is a famous businessman. He has financed a lot of small business ventures and can finance your new start-up too. After exchanging pleasantries, he asks you what your new company does. You open your mouth, and then pause. Where do you even begin?

Then, as you try to organize your thoughts, his meeting is called, and he is on his way. If you would be better prepared, you're sure that he would have stayed long enough to schedule a meeting with you too. If you were given another chance, what would you have said to this person?

Do

- Start off the task by providing a beginning sentence to get the story started, and then go around the classroom getting each one to add a new sentence to keep the story going.
- This task should be done spontaneously allowing only a little time to think (30 seconds).
- For example: There was once a student who was looking for a job after graduation

Notes for Facilitation



- Tell the participants to follow these steps to create a great pitch, but bear in mind that you'll need to vary your approach depending on what your pitch is about.
 1. **Identify Your Goal:** Start by thinking about the objective of your pitch. For instance, do you want to tell the potential clients about your organization? Do you have a great new product idea that you want to pitch to an executive or do you want a simple and engaging speech to explain what you do for a living?
 2. **Explain What You Do:** Start your pitch by describing what your organization does. Focus on the problems that you solve and how you help people. Ask yourself this question as you start writing: what do you want your audience to remember most about you? Keep in mind that your pitch should excite you first. After all, if you don't get excited about what you're saying neither will your audience. People may not remember everything that you say, but they will likely remember your enthusiasm.
 3. **Communicate Your USP:** Your elevator pitch also needs to communicate your unique selling proposition or USP. Identify what makes you, your organization or your idea unique. You'll want to communicate your USP after you've talked about what you do.
 4. **Engage with a Question:** After you communicate your USP, you need to engage your audience. To do this, prepare open-ended questions (questions that can't be answered with a "yes" or "no" answer) to involve them in the conversation. Make sure that you're able to answer any questions that he or she may have.
 5. **Put it all Together:** When you've completed each section of your pitch, put it all together. Then, read it aloud and use a stopwatch to time how long it takes. It should be no longer than 20-30 seconds. Remember, the shorter it is, the better!

Example:

Here's how your pitch could come together:

"My company deals with cloth retail online business and we use various e-commerce platforms to sell our products. This means that you can do shopping with ease and spend time on other important tasks. Unlike other similar companies, we have a strong feedback mechanism to find out exactly what people need. This means that, on average, 95 percent of our clients are happy with our products. So, how can you help us in creating our own web portal?"

6. **Practice:** Like anything else, practice makes perfect. Remember, how you say it is just as important as what you say. If you don't practice, it's likely that you'll talk too fast, sound unnatural or forget important elements of your pitch. Set a goal to practice your pitch regularly. The more you practice, the more natural your pitch will become. Practice in front of a mirror or in front of colleagues until the pitch feels natural.

Summarize

- Close the discussion by summarizing how to speak effectively as discussed in the Participant Handbook.

UNIT 8.5.4: Problem Solving & Negotiation Skills

Objectives

At the end of this unit, participants will be able to:

- Discuss how to solve problems
- List the important problem solving traits
- Discuss ways to assess problem solving skills
- Discuss the importance of negotiation
- Discuss how to negotiate

Resources to be used

- Participant Handbook

Ask

- What is a 'problem'?
- What do you think are the problems you may face in the process of becoming a successful entrepreneur?

Say

- Discuss the definition of problem as given in the Participant Handbook.
- In a hurdle race the hurdles are the obstacles on the way to reach your goal.
- Similarly, obstacles are the hurdles you may face while reaching your goal i.e. to set-up your own business. Your goal will be to reach the finishing line after crossing these hurdles.

Ask

- What do you do when you face a problem?
- How do you resolve it? You can pick examples from the question asked previously 'the problems they are likely to face in the process of becoming a successful entrepreneur'.

Say

- Discuss how to solve problems as given in the Participant Handbook.

Team Activity

- This is a group activity.
 - The groups will solve the problem and come up with the best solution in each case.
1. Unable to arrange for some extra finance for setting up a beauty parlor. The loan sanctioned and disbursed is not enough. You have tried all your contacts, friends and relatives. But unable to manage the extra amount. Bank will not sanction more amount as you have used up the complete sanction limit.
 2. You have rented a space for your business and all arrangements are done. You will be operating from the office space rented in two days. Now the owner comes up to you and says he wants to sell the place and wants you to vacate in 15 days.
 3. You have just set up your business and need extra human resource. You have tried inviting a few also tied up with an agency for getting the right candidate. But you are unable to get the right candidate.

Do 

- Divide the class into three groups. Give one scenario to each group.
- Explain the purpose and duration of the activity.
- Ask the groups to build on the scenario and present their solution as a role play.

Say 

De-brief questions:

- What was the problem?
- Is there any other alternative solution?
- Is this the best solution presented?

Ask

- Try to think of some people around you who are able to solve problems very easily. Even you or your friends might be approaching them when there is a problem. What qualities do they have? What personality traits do such people possess?

Say 

- Discuss the important traits for problem- solving as given in the Participant Handbook.

Ask

- In order to build a successful organization, you need to hire people who possess good problem solving skills. How would you assess the level of problem solving skills of potential candidates before hiring them?

Say 

- Discuss how to assess for problem- solving skills as given in the Participant Handbook.

Summarize

- Ask the participants the things that they have learnt so far.
- Ask if they have any questions related to what they have talked about so far.
- Summarize the discussion on problem solving.

Activity 

- The activity is to organize an election event. Select three volunteers from the group. They have to give a speech on their election manifesto to the class. They have to negotiate with the fellow participants and convince them to vote for them. The best negotiator will win the election.

Do 

- Ask three participants to volunteer for the activity.
- Explain the purpose and duration of the activity.
- Set guidelines pertaining to discipline and expected tasks.

Ask

- Out of the three contestants, whom would you support? Why? What did they say or do which convinced you to make your decision?
- Have you ever tried to negotiate in your personal or professional life?
- Ask the class to share some of their experiences where they have been able to strike a deal by negotiating.

Say

- Discuss “What is Negotiation?” as given in the Participant Handbook.

Ask

- Why is it important to negotiate? As an entrepreneur, where do you think that negotiation skills will be needed?

Say

- Discuss the importance of negotiation while starting a business as given in the Participant Handbook.

Say

- Discuss the important steps to negotiate as given in the Participant Handbook.

Role Play

- Conduct a role play activity.
- Ask the participants to assemble together.
- Explain the purpose and duration of the activity.
- Set guidelines pertaining to discipline and expected tasks.

Do 

- Divide them into groups of four (4) (depending on the batch size).
- Give them the hand-outs for role play scenarios.
- Two groups to be given scenarios on problem solving.
- Other two groups to be given scenarios on negotiation.
- The groups will build on the scenarios and prepare for the role play.
- Give the groups at least 5 mins to discuss and be ready with the role play.
- Invite each group one by one to come and present their role play.

Problem solving Scenario 1

Avinash has a Mobile Repair Store in Allahabad. His outlet is one of the most popular one in the vicinity and he has great rapport with his customers. He is always well-dressed, jovial and full of energy.

It's around 11 AM, when a customer barges in to the shop and starts shouting at Avinash for giving her back the instrument which is still not working. The screen of her mobile is also cracked from one side. Avinash remembered thoroughly checking the handset before handing it over to the customer. The customer threatens to sue the company and to go to Consumer Court for cheating her.

Problem solving Scenario 2

You are running a successful small scale business, Shreeji Aggarbattis. Your staff members do door to door selling and organise marketing campaigns in local markets. Your brand has established its name in last few years.

Recently, lot of customers have been coming to you and lodging complaints that your staff members indulge in malpractices. Few of them informed you that a staff member engaged them in a friendly conversation. In the meanwhile, the other gave them lesser packets of aggarbattis than they paid for.

Another set of customers lodged complaint about the misconduct and rude behavior of a particular staff member.

You often hear from your customers that the orders don't get delivered on time or wrong products get delivered.

You have already been struggling with shortage of staff and such complaints are a serious concern as it is hampering your brand image. What strategies will you adopt to solve this problem?

Negotiation Scenario 1

You have interviewed a prospective new employee who could be a key member of your new entrepreneurial venture. The new person is demanding a salary that is 20% higher than you thought based on your business plan. Finances are tight, yet you believe this person could make a significant impact on future profits. If you paid the required salary for the new person, then you would have to restructure your entire business plan. You've been searching for an individual with this skill level for three months. To the candidate is waiting for your response. Now you have to call him in to make the final negotiations.

Negotiation Scenario 2

You are a young entrepreneur who has just registered his start up project and applied for a bank loan accordingly. You receive a letter saying that your loan application has been rejected as your start up idea did not appeal to the bank and they think that it is not a revenue generating model. You have taken an appointment to meet the manager and show your negotiation skills to get your loan approved.

Notes for Facilitation



Facilitating Role Plays

Preparing for the activity

1. Carefully review the details of the scenario and the character descriptions.
2. Become familiar with the key issues being addressed in the scenario.
3. Study the provided material so that you are ready to address issues related to the situations depicted in the role-plays.
4. Anticipate and know how to address issues participants might raise during the activity.

Conducting the activity

1. Introduce the activity. Emphasize that role-playing provides participants with an opportunity to apply their new knowledge, skills, and tools in situations that simulate actual interactions with customers.
2. Ask participants to form pairs. Direct the members of each group to choose who will play the roles. Remind the groups that each participant should be given the opportunity to play/practice the different roles.
3. Conduct a demonstration so that participants become familiar with the expectations related to the roles and support materials.
4. Give the pairs/ groups 10 to 15 minutes to conduct the role-play (depending on the duration of the session).
5. After all the groups have finished with the role-play, conduct a debriefing session on each role-play.
6. Ask the groups to take five minutes to talk about what happened during the role-play. The groups should discuss the questions given in the debriefing for each role-play. Encourage participants to provide constructive criticism during their discussions.

Summarize

- Wrap the unit up after summarizing the key points and answering questions.

UNIT 8.5.5: Business Opportunity Identification: Entrepreneurs and Opportunities

Objectives

At the end of this unit, participants will be able to:

- Discuss how to identify new business opportunities
- Discuss how to identify business opportunities within their business

Resources to be used

- Participant Handbook
- Blank sheets of paper
- Pens

Ask

- How does an entrepreneur identify an opportunity?
- What do you think are the common queries or concerns faced by entrepreneurs?
- How can you identify new business opportunity?

Say

- Let's talk about opportunity, common queries or concerns faced by entrepreneurs, idea as an opportunity, factors to consider when looking for opportunities, ways to identify new business, and opportunity analysis as discussed in Participant Handbook.
- Let's do an activity to understand ways to identify business opportunities within your business.

Do

- Tell the class that this is an individual activity.
- Tell the participants to create a matrix on their notebooks.
- There will be four boxes in your matrix.
- Strength, Weakness, Opportunity and Threats will be the four headings of the matrix. This is called the SWOT matrix.
- Read out the questions to them and tell the participants they need to answer the questions asked in each matrix.
- Tell them they can also use their own understanding of themselves to fill the SWOT matrix.

Activity

Do your SWOT analysis

Strength

What are your strengths?
 What unique capabilities do you possess?
 What do you do better than others?
 What do others perceive as your strengths?

Weakness

What are your weaknesses?
 What do your competitors do better than you?

Threat

Do you have solid financial support?
What trends may negatively impact you?

Opportunity

What trends may positively impact you?
What opportunities are available to you?

- Congratulate everyone for the class activity.
- Ask the audience to applaud for themselves.
- Allot the participants sufficient time to complete this activity, but do keep a check on time.
- Ask de-brief questions to cull out information from the participants.

Ask

De-brief questions:

- What are your weaknesses according to your SWOT analysis?
- Do you think you can change your weakness into strength? How?
- Do you think you can work on your threats? How?

Summarize

- Close the discussion by summarizing ways to identify business opportunities within your business.
- Ask the participants what they have learned from this exercise.
- Ask if they have any questions related to what they have talked about so far.

UNIT 8.5.6: Entrepreneurship Support Eco-System

Objectives

At the end of this unit, participants will be able to:

- Explain the meaning of entrepreneur
- Describe the different types of entrepreneurs
- List the characteristics of entrepreneurs
- Recall entrepreneur success stories
- Discuss the entrepreneurial process
- Describe the entrepreneurship ecosystem
- Discuss the purpose of the 'Make in India' campaign
- Discuss the key schemes to promote entrepreneurs

Resources to be used

- Participant Handbook
- Chart papers
- Marker pens
- Pencils
- Colour pencils
- Scale
- Eraser
- Other requisite stationery material

Ask

- Do you think that entrepreneurs need support?
- What do you think is an eco-system?
- What do you think 'entrepreneurship support eco-system' means?

Say

- Let's learn what entrepreneurship support eco-system means.
- Discuss 'Entrepreneurship Support Eco-System' as given in the Participant Handbook.

Ask

- Can you define entrepreneurship support eco-system?
- What are the key domains of the support eco-system?

Say

- Let's learn more about these domains by conducting an activity.
- You have to make a poster showing the components of the six main domains of entrepreneurship support eco-system.

Team Activity

- Making a poster showing the entrepreneurship support eco-system.

Do 

- Divide the class into groups of four or six.
- Hand out chart paper and colored pens.
- Explain the purpose and duration of the activity.
- Go around checking the progress of each group.
- Set guidelines pertaining to discipline and expected tasks.

Activity De-brief

Ask each group to display their poster and explain the key domains of entrepreneurship support eco-system.

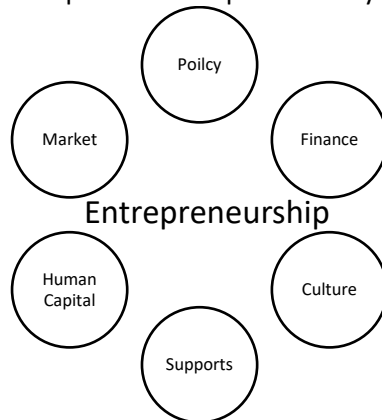
**Ask**

- What kind of government support eco-system is available for entrepreneurs in India?

Say

- Discuss 'Make in India' campaign as given in the Participant Handbook.

Team Activity

- Presentation on key schemes to promote entrepreneurs

Do 

- Divide the class into pairs.
- Number each pair from 1-15.
- Assign a scheme, same as their group number, to each group.
- Ask them to read the scheme carefully and present it to the class.
- Explain the purpose and duration of the activity.
- Go around checking the progress of each group.
- Set guidelines pertaining to discipline and expected tasks.

Activity De-brief

- Ask each group to explain the scheme offered by government to promote entrepreneurs.

Summarize

- Summarize the unit by discussing the key points and answering questions the participants may have.

UNIT 8.5.7: Risk Appetite & Resilience

Objectives

At the end of this unit, participants will be able to:

- Discuss the relationship between entrepreneurship and risk appetite
- Discuss the relationship between entrepreneurship and resilience
- Describe the characteristics of a resilient entrepreneur

Resources to be used

- Participant Handbook
- Chart papers
- Blank sheets of paper
- Pens
- Marker pens

Ask

- Can you define risk or explain what constitutes a risk?
- What do you people mean when they say, "This may be a risky proposition"?
- What risks are they talking about?

Example

- Let's have a look at these two examples:

Rohit and his family were travelling by car from Delhi to Nainital. It was their second trip there. Rohit was familiar with the road. His friends told him that the highway after Rampur was in a bad condition. They advised him to take a shortcut and turn left from Moradabad and take the Kaladhungi road. This road is in a better condition.

Since he was going with his family, and did not want to take the risk of getting lost, he left early. He took the Kaladhungi road and reached Nainital well in time.

Suresh and his family too were travelling by car from Delhi to Nainital. It was their second trip there. His friends too advised him to take a shortcut and turn left from Moradabad and take the Kaladhungi road as this road was in a better condition.

Suresh too decided to take the Kaladhungi road but he left Delhi in the afternoon. It was dark by the time he reached Kaladhungi, and he was sure that he was taking the correct turn. As it was late, he could not find anyone to give him directions. He ended up being in an unknown place that was scarcely inhabited.

Say

- Let's see what type of risks Rohit and Suresh took.
- Discuss 'Risk Appetite and Resilience' with the participants as given in the Participant Handbook.

Say

- Let's learn more about risk appetite and resilience with the help of an activity.

Team Activity

Risk Appetite

- This is a group activity.
- In the previous unit, you read success stories of Mr. Dhirubhai Ambani and Dr Karsanbhai Patel.
- Mr. Ambani left his job and started his company Reliance with just Rs. 50,000/-.
- Dr Patel kept his job went door-to-door to sell Nirma, and only when the brand started gaining popularity did he start his own company.
- What types of risk did both of them take?
- What risk factors, do you think, did they keep in mind before launching their company?
- Write the Risk Appetite Statement of both the companies.

Activity De-brief

- Who took a greater risk?
- What are the differences between the Risk Appetite Statement of both the companies?

Do

- Instruct the participants that this is group work.
- Divide the class into small groups of 4.
- Give each group a chart paper.
- Tell the participants that they have to evaluate the risks taken by Mr. Dhirubhai Ambani and Dr Karsanbhai Patel.
- Give the participants 15 minutes to discuss and write.
- Keep a check on time. Tell the group to wind up quickly if they go beyond the given time limit.

Ask

- Do you think all entrepreneurial ventures are successful?
- What happens if the first venture is not successful?
- Should the entrepreneur stop when faced with challenges or face them?

Example

Let's have a look at the following example:

Vijay Shekhar Sharma is the founder of Paytm, which is a giant Indian e-commerce. He was born in a middle-class family in Uttar Pradesh. He started his first job at an MNC. He quit after six months and built a company One97 with his friends. As One97 grew bigger, it needed more money because it was running more servers, bigger teams, and had to pay royalty. At that time, the tech bubble popped and technology companies were running in losses. Finally, money ran out. So One97 took loans and then more loans at higher rates of interest, as high as 24 per cent, and became caught in a vicious cycle.

In 2014, Paytm was launched with online wallet services after which, the company enabled online payment transactions. The company got licenses from RBI in 2016 to launch India's first ever payment bank. Moreover, the main motive of Paytm was to transform India into a cashless economy.

After demonetization came into effect, Vijay Shekhar Sharma started promoting online and digital transactions to deal with the cash crunch. In fact, the service of the company's mobile wallet is accepted across India. The logo of Paytm is now popular almost everywhere from tea stalls to major companies.

Say

- Let's see what qualities made Vijay Shekhar Sharma a resilient entrepreneur.
- Discuss Entrepreneurship and Resilience with the participants as given in the Participant Handbook.

Say

- Let's learn more about entrepreneurship and resilience with the help of an activity.

Team Activity**Entrepreneurship and Resilience**

- This is a group activity.
- Think of some entrepreneurship ventures that faced challenging times, but later resulted in success stories.
- Who is the founder of that company?
- What challenging times did it face?
- How did it overcome those challenges?
- List the resilient characteristics of the entrepreneur

Activity De-brief

- Each group to give their presentation.
- Why did you choose this company?
- What is the success story of the company?

Do

- Instruct the participants that this is group work.
- Divide the class into small groups of 4.
- Give each group a chart paper.
- Tell the participants that they have to think of an entrepreneur who faced challenging times, but eventually succeeded.
- Give the participants 15 minutes to discuss and write.
- Keep a check on time. Tell the group to wind up quickly if they go beyond the given time limit.

Summarize

- You can summarize the key points of the unit.
- Ask the participants what they learned from the activities.
- Clarify any questions or doubts they might have.

UNIT 8.5.8: Success and Failures

Objectives

At the end of this unit, participants will be able to:

- Discuss how to deal with failure

Resources to be used

- Participant Handbook

Ask

- Have you heard the quote 'nothing is impossible'?
- What do you think it means?
- Do you think that all successful entrepreneurs became famous overnight or did they have to struggle or face failure before succeeding?

Example

- Let's have a look at this example.

Shah Rukh Khan, also known as, SRK or King Khan is a force to reckon with. Did he achieve stardom overnight? Shah Rukh Khan, who has seen many struggles in his life – he has slept on streets, struggled to support himself and his sister at a very young age, and lost his parents very early in life, which led to his sister seeking mental health support. Amidst all the chaos and challenges, he kept pushing himself, and today he stands tall as the 'Badshah of Bollywood'. Certainly those years were not easy for him.

When he was young, he stood at Marine Drive and said, "I will rule this city one day". Failure was not just his companion during or before his stardom, it is still a substantial part of his life. Success does not come easy. What made him a star was his acceptance of failure and the urge to improve.

Say

- How do you define success and failure?
- What is fear?
- Discuss "success and failure" with the participants as given in the Participant Handbook.

Ask

- Have you felt or experienced fear?
- What led you to feel that emotion?
- How did you handle it?

Say

- Let's learn the about success and failure with the help of an activity.

Team Activity

- Divide the class into groups of four.
- Instruct them to think of one scenario where they have to interview a successful entrepreneur.
- Explain the purpose and duration of the activity.
- Set guidelines pertaining to discipline and expected tasks.
- They have to choose one person from the group as the interviewee and one as the interviewer.
- Go around and make sure they have understood what is to be done and are discussing the roles properly.
- Check that everyone understands their role. Give clarifications if needed. Give the participants about 5 minutes to discuss and decide their roles.
- Ask the groups to stop the discussion as soon as the time is over.
- Invite each group one by one to come and present their interview as a role play.

Notes for Facilitation



Facilitating Role Plays

Preparing for the activity

1. Carefully review the details of the scenario and the character descriptions.
2. Become familiar with the key issues being addressed in the scenario.
3. Study the provided material so that you are ready to address issues related to the situations depicted in the role plays.
4. Anticipate potential questions that might be raised by the participants and be ready to address them.

Conducting the activity

1. Introduce the activity. Emphasize that role playing provides participants with an opportunity to apply their new knowledge, skills, and tools in situations that simulate actual interactions with customers.
2. Ask participants to form pairs. Direct the members of each group to choose who will play the roles. Remind the groups that each participant should be given the opportunity to play/practice the different roles.
3. Conduct a demonstration so that participants become familiar with the expectations related to the roles and support materials.
4. To maintain spontaneity of the interactions during the role play, ask the participants not to discuss the details of their roles prior to the role play.
5. Give the pairs 15-20 minutes to conduct the role play.
6. Circulate among the groups to answer any questions that may arise and provide guidance as needed.
7. After all the pairs have finished with the role play, conduct a de-briefing session on each role play.
8. Ask the groups to take five minutes to talk about what happened during the role play. The groups should discuss the questions given in the de-briefing for each role play. Encourage participants to provide constructive criticism during their discussions.
9. Conclude the activity by asking participants to think about whether and how they might use scripted role plays in their real life.

Summarize

- Wrap the unit up after summarizing the key points and answering questions.

UNIT 8.6: Preparing to be an Entrepreneur

Key Learning Outcomes



At the end of this unit, participants will be able to:

- Discuss how market research is carried out
- Describe the 4 Ps of marketing
- Discuss the importance of idea generation
- Recall basic business terminology
- Discuss the need for CRM
- Discuss the benefits of CRM
- Discuss the need for networking
- Discuss the benefits of networking
- Discuss the importance of setting goals
- Differentiate between short-term, medium-term and long-term goals
- Discuss how to write a business plan
- Explain the financial planning process
- Discuss ways to manage your risk
- Describe the procedure and formalities for applying for bank finance
- Discuss how to manage their own enterprise
- List the important questions that every entrepreneur should ask before starting an enterprise

UNIT 8.6.1: Market Study/ The 4Ps of Marketing/ Importance of anIDEA: Understanding Market Research

Objectives

At the end of this unit, participants will be able to:

- Discuss how market research is carried out
- Describe the 4 Ps of marketing
- Discuss the importance of idea generation

Resources to be used

- Participant Handbook
- Chart papers
- Markers pens
- Blank sheets of paper

Ask

- Suppose, you want to open a restaurant, what are the factors you will consider?
- How will you promote your restaurant?

Example

- Let's have a look at this example.

Arjun was an MBA working in a company. But he wanted to start a low cost budget hostel for foreign tourists coming to India. He did a lot of market research before starting the project. Based on the information he gathered, he made his business plan. His hostel is now flourishing and he is thinking of expanding to other tourist destinations.

Say

- Discuss "Market Study" with the participants. Refer to the Participant Handbook.
- Let's learn about market study and research with the help of an activity.

Team Activity

Market Study

- This is a group activity.
- You want to start your own tuition centre.
- What type of research will you do?

Activity De-brief

- Ask each group to come forward and give a brief presentation.
- Encourage other groups to be interactive and ask questions.
- What factors did you keep in mind while doing your research?
- Based on our research would you go ahead and open a tuition centre?

Do 

- Instruct the participants that this is group work.
- Divide the class into small groups of 4 or 6.
- Give each group a chart paper.
- Tell the participants that they have to start their own tuition centre.
- Give the participants 10 minutes to discuss and write the research work they need to do.
- Keep a check on time. Tell the group to wind up quickly if they go beyond the given time limit.

Say

- By opening a tuition centre you are offering a service.

Ask

- What factors will you keep in mind before opening it?

Say

- Discuss “The 4Ps of Marketing” with the participants as given in the Participant Handbook.

Say

- Let's learn about the 4Ps of Marketing with the help of an activity.

Team Activity**4 Ps of Marketing**

- This is a group activity.
1. You have to sell a pen to four different segments:
 2. Rural villagers
 3. Rural middle class
 4. Urban middle class
 5. Upper end rich people (Niche market)
- Keeping the 4Ps of Marketing in mind, what marketing strategy will you design to sell the pen?

Activity De-brief

- Ask each group to present their strategy.
- Encourage other groups to be interactive and ask questions.

Do 

- Instruct the participants that this is group work.
- Divide the class into four groups.
- Give each group a chart paper.
- Assign each group a target audience for selling the pens:
 1. Rural villagers
 2. Rural middle class
 3. Urban middle class
 4. Upper end rich people
- Tell the participants that they have to design a marketing strategy keeping the 4Ps of Marketing in mind.
- Give the participants 20 minutes to discuss and come up with their strategy.
- Keep a check on time. Tell the group to wind up quickly if they go beyond the given time limit

Activity De-brief

- Ask each group to come forward and give a brief presentation.
- Ask each group what they kept in mind while designing their marketing strategy.
- Encourage other groups to be interactive and ask questions.

Say

- Each entrepreneur has an idea of wants he wants to sell. It may be a service or a product.
- Discuss “Importance of an IDEA” as given in the Participant Handbook.

Summarize

- Summarize the key points of the unit.
- Ask the participants what they learnt from the activities.
- Encourage them to ask if they have any doubts.

UNIT 8.6.2: Business Entity Concepts

Objectives

At the end of this unit, participants will be able to:

- Recall basic business terminology

Resources to be used

- Participant Handbook

Say

- Let's recall some basic business terminology.
- Discuss the Business Entity Concepts as given in the Participant Handbook.
- Let's learn some basic business terminology by having an activity.
- We will have a quiz today.

Activity

- The activity is a quiz.

Do

- Divide the class in two groups and give a name to each group.
- Explain the rules of the quiz. For each correct answer the group gets 1 mark.
- If the group is unable to answer the question is passed to the next group.
- Explain the purpose and duration of the activity.
- Ask the questions of the quiz.
- Keep a score of the groups.
- Set guidelines pertaining to discipline and expected tasks.

Summarize

- Summarize the unit by discussing the key points.

Notes for Facilitation

QUESTIONS FOR THE QUIZ

1. What does B2B mean?
Business to business
2. What is a financial report?
A comprehensive account of a business' transactions and expenses
3. Who is a sales prospect?
A potential customer
4. How is working capital calculated?
Current assets minus current liabilities

5. What is an estimation of the overall worth of a business called?
Valuation
6. You are buying a house. What type of transaction is it?
Complex transaction
7. How will you calculate the net income?
Revenue minus expenses
8. How is Return on Investment expressed?
As percentage
9. How will you calculate the cost of goods sold?
Cost of materials minus cost of outputs
10. What is revenue?
Total amount of income before expenses are subtracted.
11. What is a Break-Even Point?
This is the point at which the company will not make a profit or a loss. The total cost and total revenues are equal.
12. What is the formula used to calculate simple interest?
 $A = P(1 + rt)$; $R = r * 100$
13. What are the three types of business transactions?
Simple, Complex and Ongoing Transactions
14. The degrading value of an asset over time is known as .
Depreciation
15. What are the two main types of capital?
Debt and Equity

UNIT 8.6.3: CRM & Networking

Objectives

At the end of this unit, participants will be able to:

- Discuss the need for CRM
- Discuss the benefits of CRM
- Discuss the need for networking
- Discuss the benefits of networking

Resources to be used

- Participant Handbook

Ask

- Can your business run without customers/buyers?
- Who is the most important entity in any business?

Say

- The key to every success business lies on understanding the customer's expectations and providing excellent customer service.
- Discuss about CRM and its benefits. Refer to the Participant Handbook.
- Providing excellent customer service entails:
 - Treating your customers with respect.
 - Be available as per their need/ schedule
 - .Handling complaints effectively.
 - Building long lasting relationships
 - Collecting regular feedback.
- Handle customer complaints proactively. Ask “what happened”, “why it happened”, “how can it be avoided next time”, etc.
- Collecting feedback from the customers regularly will enable you to improve your good/service.
- “Let's understand it better with the help of some case scenarios. You will be given some cases within your groups. You have to analyze the case scenario that has been given to you and then find an appropriate solution to the problem.”

Do



- Divide the class into four groups of maximum six participants depending on the batch size.
- Give one case study to each group.
- Instruct them to read the case carefully.
- The group is expected to analyze and discuss the case amongst them and find a solution to the given problem.
- Put down the discussion points (de-brief questions) on the board. Give the class 5-10 minutes to discuss the case and note down their solutions.
- At the end of 10 minutes, the team should present their case solution to the class.

Team Activity

Case Study Analysis

Raju runs a business of wooden furniture. He has a huge list of customers on Facebook and WhatsApp who give him orders regularly. Ankita is one of his old and regular customers. She placed an order for a new Chester and TV cabinet via WhatsApp and requested Raju to send them as soon as possible. When the parcel reached Ankita through courier she found that Chester was broken and the TV unit was chipped from the bottom. Ankita was heartbroken. It was a complete waste of money. She sent a message to Raju on WhatsApp, expressing her anger and disappointment. Raju might lose an old customer forever if he doesn't satisfy the customer. What should Raju do to retain his customer?

Scenario 2

Rajni runs a boutique shop. She sells suits and sarees. She is one of the most successful designer in her city. Rajni swears that all the clothes in her boutique have unique designs. Smita has to attend her cousin's wedding; she goes to Rajni's boutique to buy a saree. Smita wanted a unique designer saree. Rajni customized a saree for her and sent it over the courier. When Smita had a look at the saree she realised her two friends had the same design sarees. She sent a message to Rajni on WhatsApp, expressing her anger and disappointment. Did Rajni make a false promise? Were her designs copied? What could happen to Rajni's image after this incident? What would you do if you were in Rajni's place?

Scenario 3

Shama is a beautician who offers parlour services to ladies by making home visits. Recently, Shama got her name registered on an e-commerce website. Two days earlier, she got a message from Mrs. Sushma. The appointment was fixed for next day, 11:00 am and the remuneration for the services was decided beforehand. When Shama reached there at 10:50 am, Mrs. Sushma was not at home. When Shama called her, she asked her to wait for a while. Mrs. Sushma reached home at 11:45 am. Meanwhile, Shama had to reschedule her next appointment. After availing Shama's services, Mrs. Sushma refused to pay the requisite amount and started finding faults in the services provided by her. Who was at fault in this scenario? What should you do in case the customer behaves unreasonably? What would you do if you were in Shama's place?

Scenario 4

Shailender is the manager of a car showroom. He proactively takes part in all the transactions that happen in his showroom. Vinita wants to buy a new car. She has chosen a car from Shailender's showroom. The salesperson has given her a very good discount and has also promised free service for one year. Vinita goes to the showroom and asks to complete all the formalities to purchase the car. When she sees the final bill she realize that she has not received the promised discount neither was there any mention of the free services. She immediately demands to see the Shailender. When Shailender's head asks how much discount Vinita was promised, he realised the discount will make the sale in loss. The car showroom owner might lose a customer and deal due to false commitments made by his manager. Besides, the customer might tell this to other people, creating a bad name and image for the showroom. If you owned that showroom, how would you have convinced your customer?

Say

- Now, let's discuss the problem and solution with the class.
- The group will first briefly describe the case to the class.
- Then discuss the issue identified and the proposed solution.
- Present the solution as a role play.
- Post presentation, the other groups may ask questions from the group that has presented.

Do

- Congratulate each group for the presentation/ role play.
- Ask the audience to applaud for them.
- Keep a check on time. Tell the group to wind up the discussion quickly if they go beyond the given time limit.

Say

- If your customers are happy with you they will give referrals which will help to grow your business.
- One more way of growing business is 'Networking'.
- Discuss Networking and its benefits. Refer to the Participant Handbook.

Activity

Group Discussion

- Conduct a group discussion in the class on how they can do networking for their business.

Summarize

- Ask the participants what they have learnt from this exercise/ activity.
- Ask if they have any questions related to what they have talked about so far.
- Close the discussion by summarizing the importance of CRM and Networking for entrepreneurs.
- Close the discussion by summarizing the importance of CRM and Networking for entrepreneurs.

UNIT 8.6.4: Business Plan: Why Set Goals?

Objectives

At the end of this unit, participants will be able to:

- Discuss the importance of setting goals
- Differentiate between short-term, medium-term and long-term goals
- Discuss how to write a business plan
- Explain the financial planning process
- Discuss ways to manage your risk

Resources to be used

- Participant Handbook
- Chart papers
- Blank papers
- Marker pens
- Ruler

Ask

- Remember we had written SMART Goals in a previous session? Let's try and recall why it is important to set goals?
- While framing SMART goals, we talked about 'T' in SMART, which was 'Time Bound'? What do we mean by time bound goals?
- What time limit did you set for your goal- 3 weeks, 3 years, 10 years?

Say

- Talk about short term, long term and medium term goals, as discussed in the Participant Handbook.

Ask

- As you are planning to become an entrepreneur, you must have thought of an idea for a start-up. What is your business idea?

Do

- Ask few participants to share their business ideas.

Ask

- Have you created a business plan for your business idea?
- Do you think it is important to have a business plan in place? Why/ why not?

Say

- Talk about 'Why Create a Business Plan' as discussed in the Participant Handbook.
- Let's understand it better with the help of an activity.

Team Activity

Writing a business Plan

- This is a group activity.
- Give the groups the required resources such as chart paper and markers.
- This activity is divided into two parts:
 1. Create a business idea
 2. Develop a business plan
- The group will discuss and come up with a new business idea and present their idea to the class.
- In the second part of the activity the group will develop a business plan for the business idea.
- The business plan prepared will be presented by the groups to the class.

MY BUSINESS PLAN
Executive Summary: What is your Mission Statement?
Business Description: What is the nature of your business?
Market Analysis: What is your target market?
Organization and Management: What is your company's organizational structure?
Service or Product Line: What is the lifecycle of your product/ service?
Marketing and Sales: How will you advertise and sell your products?
Funding Request: How much fund is required and from where?

Say

- Teams will need to brainstorm for this part of the activity.
- Use the blank papers for the second part of this activity
- Make your business plan on a chart paper based on the following parameters:
 1. Executive Summary
 2. Business Description
 3. Market Analysis
 4. Organization and Management
 5. Service or Product Line
 6. Marketing and Sales
- Explain each parameter in detail as done in the Participant Handbook.
- Discuss each parameter with the business idea examples of the groups.
- Groups will discuss and develop the business plan for their business idea.

Say

- Now, let's share our plan with the class.
- Each group will briefly describe the plan to the class.
- Post presentation, the other groups may ask questions to the group who have presented their plan.

Do



- Congratulate each group for sharing their points.
- Ask the audience to applaud for them.
- Keep a check on time. Tell group to wind up the discussion quickly if they go beyond the given time limit.

Say

- Along with a business plan, you need to create a financial plan and evaluate the risk involved with your start up.
- Discuss 'Financial Planning' and 'Risk Management' in detail as given in the Participant Handbook.

Summarize

- Ask the participants what they have learnt from this exercise/ activity.
- Ask if they have any questions related to what they have talked about so far.

Notes for Facilitation



- Keep the business plan format ready in a flipchart to display it during the activity.

UNIT 8.6.5: Procedures and Formalities for Bank Finance

Objectives

At the end of this unit, participants will be able to:

- Describe the procedure and formalities for applying for bank finance

Resources to be used

- Participant Handbook
- Bank loan/finance form sample

Ask

- While preparing a business plan in the last session, we discussed financial planning to arrange financial resources for your start-up. Therefore, how will you collect funds to start your business?

Say

- While most entrepreneurs think 'product' is the most difficult thing to decide for a business, start-up capital poses an even a bigger obstacle. Though there are various ways of funding the business, to convince investors to invest money is the most challenging.
- Some of the funding options available in India are:
 - **Bootstrapping:** Also called self-financing is the easiest way of financing
 - **Crowd funding:** Funds are collected by consumers pre-ordering or donating for starting the business.
 - **Angel investors:** Individual or group of investors investing in the company
 - **Venture capitalists:** Venture capitals are professionally managed funds who invest in companies that have huge potential. They usually invest in a business against equity.
 - **Bank loans:** The most popular method in India.
 - **Microfinance Providers or NBFCs**
 - **Government programmes**
- Let us know discuss the most popular method i.e. bank finance in detail here.

Do



- Discuss the list of documents that are required to apply for a loan like letter of introduction, business brochure, references of other banks, and financial statements.
- Explain the details to be filled in a loan application form.
- Divide the class into groups. Give each group a loan application form.
- Ask the groups to discuss and fill the form.

Summarize

- Close the discussion by summarizing the important documents needed for bank loan.
- Ask the participants if they have any questions related to what they have talked about so far.

Notes for Facilitation

- Checklist of documents is provided as resources for the session.
- You can make some copies and distribute it during the group activity.
- Download sample loan application forms from any nationalised bank's website. Print sufficient copies to circulate it amongst the groups.

CHECKLIST OF DOCUMENTS TO BE SUBMITTED ALONG WITH LOAN APPLICATION (Common for all banks)
1. Audited financial statements of the business concern for the last three years
2. Provisional financial statements for the half – year ended on
3. Audited financial statements of associate concern/s for the last three years
4. Copy of QIS II for the previous quarter ended on
5. Operational details in Annexure I
6. CMA data for the last three years, estimates for current year and projection for the next year
7. Term loan/DPG requirements in Annexure II
8. List of machinery in respect of machinery offered as security in Annexure III
9. Additional details for export advances furnished in Annexure IV
10. Property statements of all directors/partners/proprietor/guarantors
11. Copies of ITAO of the company for the last three years
12. Copies of ITAOs/WTAOs of the directors/partners/proprietor and guarantors
13. Copies of certificate from banks and financial institutions certifying the latest liability with them
14. Copy of board resolution authorizing the company to apply to your bank for the credit facilities mentioned in application
15. Copy of memorandum and article of association (in case of limited company)/partnership deed (in case of partnership firm)
16. Cash budget for the current year and next year in case of contractors and seasonal industries

UNIT 8.6.6: Enterprise Management – An Overview: How to Manage Your Enterprise?

Objectives

At the end of this unit, participants will be able to:

- Discuss how to manage their own enterprise

Resources to be used

- Participant Handbook

Ask

- Having set-up a business, do you think it is possible to do everything on your own?
- Does one require trained persons for help?
- What does management mean?

Say



- Let's have a look at this example:

Kapil had a small business that was beginning to pick up pace. He wanted to expand his business, and therefore employed few more people. One day, as he was walking past Ramesh, one of his new employees, he overheard Ramesh talking rudely to a customer on the phone. This set him thinking. Kapil realised that he should have regular team meetings to motivate his employees and speak with them about any problems they might be facing during work. He should also conduct training sessions on new practices, soft skills, and technology, and develop work ethics manual for managing his enterprise.

Say



- Was Kapil correct in his approach or he should have scolded Ramesh instantly in front of his other employees?
- Discuss “Enterprise Management – An Overview” with the participants as given in the Participant Handbook.

Say



- Let's learn how to effectively manage an enterprise or business through an activity.

Team Activity

Enterprise Management

- This is a group activity.
- Design a matrix listing the topics and key words that are needed to run an enterprise effectively and smoothly.

Activity De-brief

- Have each group present their matrix.
- Encourage participants of the other groups to ask question about each other's presentation.

Do 

- Instruct the participants that this is group work.
- Divide the class into small groups of 4.
- Give each group a chart paper and coloured pen.
- Tell the participants that they have make a matrix they need to fill.
- They have to write the main topics and key words that will them effectively manage their enterprise.
- Give the participants 15 minutes to discuss and write.
- Keep a check on time. Tell the group to wind up quickly if they go beyond the given time limit.

Summarize

- Ask the participants what they have learned from this exercise/activity.
- Ask if they have any questions related to what they have talked about so far.
- Close the discussion by summarizing the importance of effective management to run an enterprise as given in the Participant Handbook.

UNIT 8.6.7: 20 Questions to Ask Yourself before Considering Entrepreneurship

Objectives

At the end of this unit, participants will be able to:

- List the important questions that every entrepreneur should ask before starting an enterprise

Resources to be used

- Participant Handbook
- Blank sheets of paper
- Pens

Ask

- Why do you want to become an entrepreneur?

Say



- It is very important to know why you want to become an entrepreneur. Your personal goals for becoming an entrepreneur play a key role in the success of your business. Your goals should be clear well before you start your business.
- Apart from the goals, the other aspects of business that you need to bear in mind are the potential problems that you may face to set-up, your areas of interest, and all the other dimensions of the business.
- Let's understand it better with the help of some questions that every entrepreneur should ask before starting their own business.
- Open the Participant Handbook section named '20 Questions to Ask Yourself Before Considering Entrepreneurship'. You have to answer the questions individually.
- Then, we will have a class discussion on all the questions.

Do



- Read out the questions one by one in front of all the participants.
- Participants have to answer all the one by one questions.
- Give the class 10-15 minutes to note down their answers.
- At the end of 15 minutes, open the discussion for all the questions.
- Moderate the discussion by focusing on the relevant points.
- Keep a check on time and don't let the discussion get sabotaged or lose track of time. Ensure all the questions are covered and discussed.

Summarize

- Ask the participants what they have learned from this exercise/activity.
- Ask if they have any questions related to what they have talked about so far



Skill India
कौशल भारत - कुशल भारत



सत्यमेव जयते
GOVERNMENT OF INDIA
MINISTRY OF SKILL DEVELOPMENT
& ENTREPRENEURSHIP



N · S · D · C
National
Skill Development
Corporation

Transforming the skill landscape



Media & Entertainment Skills Council

9. Annexures

Annexure I: Training Delivery Plan

Annexure II: Assessment Criteria

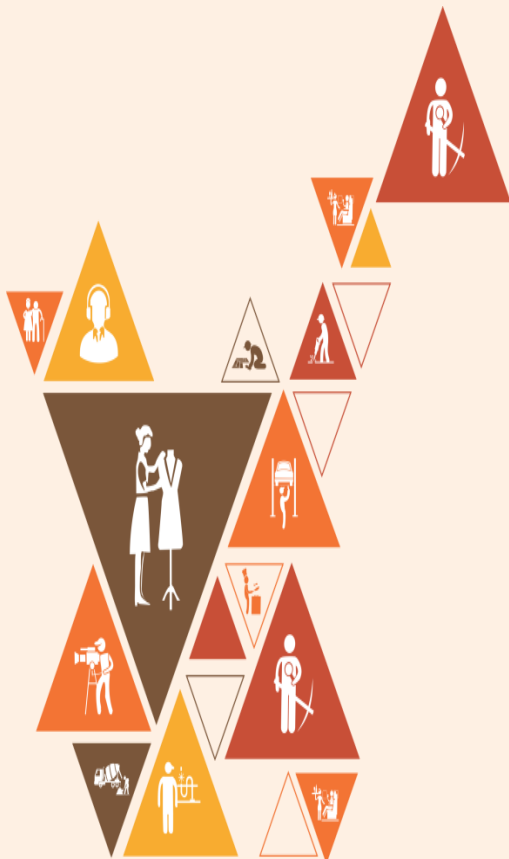

Annexure I

Training Delivery Plan

Training Delivery Plan			
Program Name:	Modeller		
Qualification Pack Name & Ref. ID	MES/Q2501		
Version No.	1.0	Version Update Date	29 th July, 2015
Pre-requisites to Training	Graduate/ ITI/Diploma, from any other polytechnic/ reputed institute in the core subject		
Training outcomes	<p>By the end of this program, the participants would have achieved the following competencies:</p> <ul style="list-style-type: none"> • Interpret the script / story brief • Identify the scope for creation of model as per story outline • Recognise the right tools (Software) to be utilized. • Identify and design various components of Model • Design characters • Create models of props and characters as per script / story • Inspect the created models in line with the specification • Maintain workplace health and safety 		

Sl. No.	Module Name	Session Name	Session Objective	NOS Ref.	Methodology	Training Tools/ Aids	Duration
1.	Introduction	Introduction to Media Industry Modeler- Roles and responsibilities	<ul style="list-style-type: none"> • Describe the role and responsibilities of a modeller with respect to the media and entertainment industry 	Bridge Module	<ul style="list-style-type: none"> • Facilitator-led – Discussion 	Laptop, White board, Marker, Projector	3 hrs.
		Introduction to 3D Modelling	<ul style="list-style-type: none"> • Discuss the application of models to be created by modeler • Discuss the process involved in creation of model 	Bridge module	<ul style="list-style-type: none"> • Facilitator-led Discussion • Demonstration 	Laptop, White board, Marker, Projector	1 hrs.

2	Interpret the script/brief/story board	Principles of Animation	<ul style="list-style-type: none"> Describe the ways of analysing a script/storyboard 	MES/N2501 PC1, KA1- KA3	<ul style="list-style-type: none"> Facilitator-led Discussion Demonstration 	Laptop, White board, Marker, Projector	2 hrs.
		Animation Production Process	<ul style="list-style-type: none"> Describe guidelines to animation Character sketching and Drawing of human anatomy. Production concepts and their applicability to each project 	MES/N2501 PC2-PC6, KB1-KB5	<ul style="list-style-type: none"> Facilitator-led Discussion Demonstration 	Laptop, White board, Marker, Projector, Modelling / Animation Software	2 hrs.
		Animation techniques	<ul style="list-style-type: none"> Discuss fundamental principles of design and colour theory such as layout, composition etc. 	MES/N2501 PC2, KB6, KB7	<ul style="list-style-type: none"> Demonstration in the laboratory 	Laptop, White board, Marker, Projector, Modelling / Animation Software	6 hrs.
		3 D Modeling Process	<ul style="list-style-type: none"> Distinguish between the components of model to be created 	MES/N2501 KB6	<ul style="list-style-type: none"> Facilitator-led Discussion 	Laptop, White board, Marker, Projector	3 hrs.
		3 D process terminology	<ul style="list-style-type: none"> Identify necessary tools for designing the model 	MES/N2501 KB4,KB5	<ul style="list-style-type: none"> Facilitator-led Discussion 	Laptop, White board, Marker, Projector	3 hrs.
		3 D modelling Techniques	<ul style="list-style-type: none"> Interpret the sequences for creating model as per story line Discuss the challenges which may be faced during production 	MES/N2501 KB5,KB6, KB8,KB9	<ul style="list-style-type: none"> Facilitator-led Discussion Demonstration in laboratory 	Laptop, White board, Marker, Projector, Modelling / Animation Software	8 hrs.
			Life Drawings: Human Anatomy Fundamentals	<ul style="list-style-type: none"> Identify necessary tools for designing the model 	MES/N2501 PC3, PC4, KB3-KB5	<ul style="list-style-type: none"> Facilitator-led Discussion Demonstration in laboratory 	Laptop, White board, Marker, Projector, Modelling / Animation Software

		Animation pre-production process	<ul style="list-style-type: none"> Discuss Principles of Production as per projects. 	MES/N2501 PC5,KB6	<ul style="list-style-type: none"> Facilitator-led Discussion 		3 hrs.
		Animation production and post production	<ul style="list-style-type: none"> Discuss Principles of Production as per projects. Identify various techniques available for animating objects 	MES/N2501 PC5,KB4, KB5, KB6	<ul style="list-style-type: none"> Facilitator-led Discussion Demonstration in laboratory 	Laptop, White board, Marker, Projector, Modelling / Animation Software	7 hrs.
		Requirements and Specifications of the Project	<ul style="list-style-type: none"> Prepare the technical need sheet relevant to project for which model needs to be prepared 	MES/N2501 PC5	<ul style="list-style-type: none"> Facilitator-led Discussion 		2 hrs.
		Create Hookup Poses and Animation	<ul style="list-style-type: none"> Identify necessary tools for designing the model Interpret the sequences for creating model as per story line 	MES/N2501 PC4,KB4	<ul style="list-style-type: none"> Facilitator-led Discussion Demonstration in laboratory 	Laptop, White board, Marker, Projector, Modelling / Animation Software	7 hrs.
3	Prepare computer generated models	Designing the model	<ul style="list-style-type: none"> Create model as per the story 	MES/N2502 PC1,KA1	<ul style="list-style-type: none"> Facilitator-led Discussion Demonstration in laboratory 	Laptop, White board, Marker, Projector, Modelling / Animation Software	4 hrs.
		Create Prototypes/Pilots for Testing	<ul style="list-style-type: none"> Create Prototypes/Pilots for Testing 	MES/N2502 PC2,KA1-KA3	<ul style="list-style-type: none"> Facilitator-led Discussion Demonstration in laboratory 	Laptop, White board, Marker, Projector, Modelling / Animation Software	7 hrs.
		The Maya User Interface	<ul style="list-style-type: none"> Describe principles of 3D modelling and animation 	MES/N2502 KB1	<ul style="list-style-type: none"> Facilitator-led Discussion Demonstration in laboratory 	Laptop, White board, Marker, Projector, Modelling / Animation Software	4 hrs.

	Learning Maya User Interface	<ul style="list-style-type: none"> Create 3D Animation, Pipeline and Modelling 	MES/N2502 PC2, KA2,KB8	<ul style="list-style-type: none"> Facilitator-led Discussion Demonstration in laboratory 	Laptop, White board, Marker, Projector, Modelling / Animation Software	7 hrs.
	Animation Controls, the Command Line, and the Help Line	<ul style="list-style-type: none"> Create 3D Animation, Pipeline and Modelling 	MES/N2502 PC2, KA2,KB8	<ul style="list-style-type: none"> Facilitator-led Discussion Demonstration in laboratory 	Laptop, White board, Marker, Projector, Modelling / Animation Software	3 hrs.
	Working with NURBS Surfaces	<ul style="list-style-type: none"> Define the different ways of modeling - polygon modelling, nurbs modelling or the surface modelling, etc. 	MES/N2502 PC3,KB1	<ul style="list-style-type: none"> Facilitator-led Discussion Demonstration in laboratory 	Laptop, White board, Marker, Projector, Modelling / Animation Software	4 hrs.
	Learn the NURBS Primitives	<ul style="list-style-type: none"> Demonstrate the process of designing 3D models using 3D primitive objects (interior and exterior environment) 	MES/N2502 PC3, KA3, KB1, KB13	<ul style="list-style-type: none"> Facilitator-led Discussion Demonstration in laboratory 	Laptop, White board, Marker, Projector, Modelling / Animation Software	7 hrs.
	Boolean Tools	<ul style="list-style-type: none"> Design the model as per the script Demonstrate the use of various modelling software and tools 	MES/N2502 PC4, KB15-KB17	<ul style="list-style-type: none"> Facilitator-led Discussion Demonstration in laboratory 	Laptop, White board, Marker, Projector, Modelling / Animation Software	6 hrs.
	Use Boolean Tools	<ul style="list-style-type: none"> Design the model as per the script Demonstrate the use of various modelling software and tools 	MES/N2502 PC3,KB1KB2, KB19, KB11-12	<ul style="list-style-type: none"> Facilitator-led Discussion Demonstration in laboratory 	Laptop, White board, Marker, Projector, Modelling / Animation Software	4 hrs.
	Animating with Keyframes	<ul style="list-style-type: none"> Create various components / parts of model 	MES/N2502 KB11-12,KB18	<ul style="list-style-type: none"> Facilitator-led Discussion 	Laptop, White board, Marker, Projector, Modelling /	7 hrs.

					<ul style="list-style-type: none"> • Demonstration in laboratory 	Animation Software	
	Set Key Frames	<ul style="list-style-type: none"> • Create character design/frame and structure the character as model 	MES/N2502 KB11	<ul style="list-style-type: none"> • Facilitator-led Discussion • Demonstration in laboratory 		Laptop, White board, Marker, Projector, modelling / animation Software	5 hrs.
	Animate Using Motion Paths	<ul style="list-style-type: none"> • Identify components for re-designing and editing purposes 	MES/N2502 KB6-7, KB13	<ul style="list-style-type: none"> • Facilitator-led Discussion 		Laptop, White board, Marker, Projector, modelling / animation Software	5 hrs.
	Animate Using Motion Paths	<ul style="list-style-type: none"> • Demonstrate the steps involved in checking for any penetration or overlap in texturing or in animation 	MES/N2502 KB2-4,KB17	<ul style="list-style-type: none"> • Facilitator-led Discussion • Demonstration in laboratory 		Laptop, White board, Marker, Projector, modelling / animation Software	5 hrs.
	Creating a new scene	<ul style="list-style-type: none"> • Create three dimensional models 	MES/N2502 KB6-11	<ul style="list-style-type: none"> • Facilitator-led Discussion 		Laptop, White board, Marker, Projector, modelling / animation Software	5 hrs.
	Creating, manipulating and Viewing Objects	<ul style="list-style-type: none"> • Select and work on Models • Apply motion with mouse • Create 3D primitive objects. 	MES/N2502 KB1-KB11, KB16	<ul style="list-style-type: none"> • Facilitator-led Discussion • Demonstration in laboratory 		Laptop, White board, Marker, Projector, modelling / animation Software	3 hrs.
	Camera tools	<ul style="list-style-type: none"> • Identify and use camera tools. 	MES/N2502 KB18	<ul style="list-style-type: none"> • Facilitator-led Discussion 		Laptop, White board, Marker, Projector, modelling / animation Software	5 hrs.

		Workflow Overview	<ul style="list-style-type: none"> Demonstrate the use of various modelling software and tools 	MES/N2502 KB10-13	<ul style="list-style-type: none"> Facilitator-led Discussion Demonstration in laboratory 	Laptop, White board, Marker, Projector, modelling / animation Software	6 hrs.
		Viewing the Maya 3D Scene	<ul style="list-style-type: none"> Create character design/frame and structure the character as model Create the visual style of the project, including colour sets, mood, etc. Identify components for re-designing and editing purposes 	MES/N2502 PC3, KB7-12 KB6-KB8	<ul style="list-style-type: none"> Facilitator-led Discussion Demonstration in laboratory 	Laptop, White board, Marker, Projector, modelling / animation Software	4 hrs.
		Polygonal Modelling	<ul style="list-style-type: none"> Define the different ways of modeling - polygon modelling, nurbs modelling or the surface modelling, etc. Apply 3D animation techniques on Maya Software- Polygonal Modelling 	MES/N2502 PC3, KB3- KB6, KB11,KB12	<ul style="list-style-type: none"> Facilitator-led Discussion 	Laptop, White board, Marker, Projector, modelling / animation Software	7 hrs.
		Choosing Modeling Preference	<ul style="list-style-type: none"> Define the different ways of modeling - polygon modelling, nurbs modelling or the surface modelling, etc. Demonstrate the process of designing 3D models using 3D primitive objects (interior and 	MES/N2502 PC3, KB3-KB6, KB11, KB12	<ul style="list-style-type: none"> Facilitator-led Discussion 	Laptop, White board, Marker, Projector, modelling / animation Software	4 hrs.

		exterior environment)				
	Creating a Polygon Primitive	<ul style="list-style-type: none"> • Create different ways of modeling - polygon modelling, nurbs modelling or the surface modelling, etc. 	MES/N2502 KB15-16	<ul style="list-style-type: none"> • Facilitator-led Discussion • Demonstration in laboratory 	Laptop, White board, Marker, Projector, modelling / animation Software	5 hrs.
	Drawing a Polygon	<ul style="list-style-type: none"> • Create polygon modelling 	MES/N2502 KB1	<ul style="list-style-type: none"> • Facilitator-led Discussion • Demonstration in laboratory 	Laptop, White board, Marker, Projector, modelling / animation Software	5 hrs.
	NURBS Modeling	<ul style="list-style-type: none"> • Apply animation techniques on Maya Software-NURBS 	MES/N2502 KB12	<ul style="list-style-type: none"> • Facilitator-led Discussion 	Laptop, White board, Marker, Projector, modelling / animation Software	5 hrs.
	Creating surfaces	<ul style="list-style-type: none"> • Create the visual style of the project, including colour sets, mood, etc. 	MES/N2502 KB17	<ul style="list-style-type: none"> • Facilitator-led Discussion • Demonstration in laboratory 	Laptop, White board, Marker, Projector, modelling / animation Software	3 hrs.
	Animation	<ul style="list-style-type: none"> • Apply animation techniques on Maya Software-Animation 	MES/N2502 KB12	<ul style="list-style-type: none"> • Facilitator-led Discussion 	Laptop, White board, Marker, Projector, modelling / animation Software	5 hrs.
	3D Animation	<ul style="list-style-type: none"> • Apply 3D animation techniques on Maya Software-Animation 	MES/N2502 KB12	<ul style="list-style-type: none"> • Facilitator-led Discussion • Demonstration in laboratory 	Laptop, White board, Marker, Projector, modelling / animation Software	5 hrs.

4	Testing and Other Terminologies	Testing and Other Terminologies	<ul style="list-style-type: none"> Measure quality of model and rectify the issues 	MES/N2503 PC1,PC2, PC3,KB1-KB3	<ul style="list-style-type: none"> Facilitator-led Discussion 	Laptop, White board, Marker, Projector	.4 hrs.
	Testing of a Model/Project	Testing of a Model/Project	<ul style="list-style-type: none"> Examine normal for orientation of polygon face 	MES/N2503 PC3, KB6-KB10	<ul style="list-style-type: none"> Facilitator-led Discussion 	Laptop, White board, Marker, Projector, modelling / animation Software	4 hrs.
	Testing of Model	Testing of Model	<ul style="list-style-type: none"> Test model/project 	MES/N2503 KB17, KB18	<ul style="list-style-type: none"> Facilitator-led Discussion Demonstration in laboratory 	Laptop, White board, Marker, Projector, modelling / animation Software	9 hrs.
	Test planning process	Test planning process	<ul style="list-style-type: none"> Identify test planning process 	MES/N2503 KB17-KB21	<ul style="list-style-type: none"> Facilitator-led Discussion 	Laptop, White board, Marker, Projector, modelling / animation Software	4 hrs.
	Introduction to UV mapping	Introduction to UV mapping	<ul style="list-style-type: none"> Describe UV mapping 	MES/N2503 PC3-PC5, KB4-KB12	<ul style="list-style-type: none"> Facilitator-led Discussion 	Laptop, White board, Marker, Projector, modelling / animation Software	4 hrs.
	UVs and texture mapping	UVs and texture mapping	<ul style="list-style-type: none"> Check UVs for smooth texturing and shading 	MES/N2503 KB5-KB7	<ul style="list-style-type: none"> Facilitator-led Discussion Demonstration in laboratory 	Laptop, White board, Marker, Projector, modelling / animation Software	9 hrs.
	UV mapping	UV mapping	<ul style="list-style-type: none"> Demonstrate the steps to be followed to correct issues found in the model during the test 	MES/N2503 KB14-KB21	<ul style="list-style-type: none"> Facilitator-led Discussion Demonstration in laboratory 	Laptop, White board, Marker, Projector, modelling / animation Software	9 hrs.

						animation Software	
		UV Mapping tips	<ul style="list-style-type: none"> Check the topology for smooth movement 	MES/N2503 KB4-KB7	<ul style="list-style-type: none"> Facilitator-led Discussion 	Laptop, White board, Marker, Projector, modelling / animation Software	4 hrs.
		Spacing UV shells	<ul style="list-style-type: none"> Check UV shell spacing 	MES/N2503 KB5-KB14	<ul style="list-style-type: none"> Facilitator-led Discussion Demonstration in laboratory 	Laptop, White board, Marker, Projector, modelling / animation Software	9 hrs.
		Snapping	<ul style="list-style-type: none"> Demonstrate snapping 	MES/N2503 KB16	<ul style="list-style-type: none"> Facilitator-led Discussion Demonstration in laboratory 	Laptop, White board, Marker, Projector, modelling / animation Software	9 hrs.
5	Maintain Workplace Health and Safety	Maintaining Health, Safety and Security at Workplace	<ul style="list-style-type: none"> Elaborate on health & safety related instructions at the workplace 	MES/N0104 PC1-3,PC5	<ul style="list-style-type: none"> Facilitator-led - discussion 	Charts of good personal health practices, note pad, , audio-visual clips	4 hrs.
		Personal Protective Equipment	<ul style="list-style-type: none"> Identification and usage of Personal Protective Equipments 	MES/N0104 PC8,PC9	<ul style="list-style-type: none"> Facilitator-led - discussion 	Chart for PPE, note pad, , audio-visual clips	3 hrs.
		Understanding Ergonomics	<ul style="list-style-type: none"> Build an understanding of Importance of Ergonomics at the workplace 	MES/N0104 PC7-9	<ul style="list-style-type: none"> Facilitator-led - discussion 	Audio-visual clips. Various posture charts	6 hrs.
		Workplace hazards	<ul style="list-style-type: none"> Elaborate on probable hazards at the workplace and handling them 	MES/N0104 PC5-PC12	<ul style="list-style-type: none"> Facilitator-led - discussion 	Audio-visual clips, Process charts	3 hrs.

		Machine malfunctions	<ul style="list-style-type: none"> Summarize probable machine / equipment malfunctions 	MES/N0104 KB1,KB2	<ul style="list-style-type: none"> Facilitator-led - discussion 	Diagrams, charts etc.	3 hrs.
		First aid	<ul style="list-style-type: none"> Discuss first Aid & its application 	MES/N0104 KA2,3,KB3-5	<ul style="list-style-type: none"> Facilitator-led - discussion 	Chart for First Aid materials, First Aid Box	3 hrs.
		How to wear PPE	<ul style="list-style-type: none"> Demonstrate wearing and taking off PPE 	MES/N0104 KA1-4	<ul style="list-style-type: none"> Practical Lab 	Process charts, flow charts, Various PPEs	6 hrs.
		Mock drills	<ul style="list-style-type: none"> Take part in Mock Drills / Evacuation Make use of First Aid 	MES/N0104 PC4,KB6	<ul style="list-style-type: none"> Practical Lab 	Mock drill video, mock drill charts, first aid box	8 hrs.
6	Soft Skills and Communication Skills	Soft Skills and Communication Skills	<ul style="list-style-type: none"> Explain towards managing job related stress effectively Build an understanding about work ethics 	Bridge Module	<ul style="list-style-type: none"> Facilitator-led - discussion 	Presentation , Audi-visual clips, Role plays	
			<ul style="list-style-type: none"> Develop awareness towards AIDS Discuss the importance of health and hygiene Develop awareness about ill effects of alcohol and tobacco 	Bridge Module	<ul style="list-style-type: none"> Facilitator-led - discussion 	Presentation , Audi-visual clips, Role plays	
			<ul style="list-style-type: none"> Creating a Resume 	Bridge Module	<ul style="list-style-type: none"> Facilitator-led - discussion 	Resume templates	
		Establishing Learner's Understanding	<ul style="list-style-type: none"> Analyze and examine learning confirmation 	Bridge Module	<ul style="list-style-type: none"> Facilitator led question-answer session 	Pen & paper exercise, question answer session, Process	

					<ul style="list-style-type: none"> Evaluate the learner for their understanding & proficiency of the module Process based evaluation 	charts, schematic diagrams, illustrations, charts, images	
7	IT Skills	Describe Computer system	<ul style="list-style-type: none"> Discuss computer & computer peripherals Discuss the advantages and disadvantages of computer 	Digital Literacy	<ul style="list-style-type: none"> Facilitator-led - discussion 	Computer, computer peripherals, schematic diagrams, charts, images, illustration	
		Uses of computer	<ul style="list-style-type: none"> Explain how to perform simple tasks using computer 	Digital Literacy	<ul style="list-style-type: none"> Facilitator-led - discussion 	Computer, computer peripherals, schematic diagrams, charts, images, illustration	
		Components of Computer	<ul style="list-style-type: none"> Identify and use different parts and components of computer 	Digital Literacy	<ul style="list-style-type: none"> Facilitator-led - discussion 	Computer, computer peripherals, schematic diagrams, charts, images, illustration	
		Concept of Operating System	<ul style="list-style-type: none"> Discuss about operating windows and doing simple tasks 	Digital Literacy	<ul style="list-style-type: none"> Facilitator-led – discussion 	Computer, computer peripherals, schematic diagrams, charts, images, illustration	
		MS Word	<ul style="list-style-type: none"> Explain the procedure of writing and printing a document 	Digital Literacy	<ul style="list-style-type: none"> Facilitator-led – discussion 	Computer, computer peripherals, schematic diagrams, charts, images, illustration pen, duster,	

						white board, marker, Computer, Projector etc.	
		MS Power Point	<ul style="list-style-type: none"> Explain formatting a slide and making a presentation using MS – PowerPoint. 	Digital Literacy	<ul style="list-style-type: none"> Facilitator-led – discussion 	Computer, computer peripherals, schematic diagrams, charts, images, illustration	
		MS Excel	<ul style="list-style-type: none"> Explain formatting cell contents and other features in MS-Excel 	Digital Literacy	<ul style="list-style-type: none"> Facilitator-led – discussion 	Computer, computer peripherals, schematic diagrams, charts, images, illustration	
		Use Internet and email	<ul style="list-style-type: none"> List methods of using the internet to gather information 	Digital Literacy	<ul style="list-style-type: none"> Facilitator-led – discussion 	Computer, computer peripherals, schematic diagrams, charts, images, illustration	
		Establishing Learner's Understanding	<ul style="list-style-type: none"> Analyze and examine learning confirmation 	Digital Literacy	<ul style="list-style-type: none"> Facilitator led question-answer session Evaluate the learner for their understanding & proficiency of the module Process based evaluation 	Pen & paper exercise, question answer session, Process charts, schematic diagrams, illustrations, charts, images	
8	Employability and Entrepreneurship skills	Personal Strengths & Value Systems	<ul style="list-style-type: none"> Build awareness towards maintain health & hygiene Develop life skills 	Bridge Module	<ul style="list-style-type: none"> Facilitator-led – discussion 	Charts, images, illustration	5 hrs.

			<ul style="list-style-type: none"> • Elaborate on self-analysis & self-motivation • Explain stress & anger management • Illustrate the qualities of a successful Entrepreneur • Discuss the right way of conducting self in workplace • Discuss about work ethics 				
	Digital Literacy: A Recap	<ul style="list-style-type: none"> • Basic parts of computer & computer peripherals • Basic computer terminology • Basic computer application (MS office, Outlook, Internet) • Basic features of using e-commerce 	Bridge Module	<ul style="list-style-type: none"> • Facilitator-led – discussion 	Charts, images, illustration	8 hrs.	
	Money Matters	<ul style="list-style-type: none"> • Discuss opening and operating a bank account • Discuss the importance and methods of savings • Discuss about investment options • Discuss about cost of operations • Discuss about types of Fund Transfer 	Bridge Module	<ul style="list-style-type: none"> • Facilitator-led – discussion 	Charts, images, illustration	3 hrs.	
	Preparing for Employment and Self Employment	<ul style="list-style-type: none"> • Discuss the steps to prepare for an interview • Discuss the steps to create an effective Resume • Discuss the most 	Bridge Module	<ul style="list-style-type: none"> • Facilitator-led – discussion 	Charts, images, illustration, resume templates	8 hrs.	

			<p>frequently asked interview questions</p> <ul style="list-style-type: none"> • Discuss how to answer the most frequently asked interview questions • Discuss basic workplace terminology • 				
	Analyse Entrepreneurship		<ul style="list-style-type: none"> • Discuss the concept and characteristics of entrepreneurship • Describe the different types of enterprises • Elaborate on establishing effective leadership • Discuss about skills for undertaking team work • Explain importance of effective communication • Discuss about Negotiation Skills and Conflict Resolution • Explain about Entrepreneurship ecosystem in India 	Bridge Module	<ul style="list-style-type: none"> • Facilitator-led – discussion 	Charts, images, illustration	3 hrs.
	Preparing to be an Entrepreneur		<ul style="list-style-type: none"> • Explain basic marketing skills • Recall basic business terminology • Explain CRM • Elaborate on setting and achieving goals • Discuss the procedure of making a business plan 	Bridge Module	<ul style="list-style-type: none"> • Facilitator-led – discussion 	Charts, images, illustration	7 hrs.

			<ul style="list-style-type: none"> List steps in carrying out a market research Explain Business & Financial Planning Process Discuss about ways of managing a enterprise 				
	Establishing Learner's Understanding		<ul style="list-style-type: none"> Analyze and examine learning confirmation 	Bridge Module	<ul style="list-style-type: none"> Facilitator led question-answer session Evaluate the learner for their understanding & proficiency of the module Process based evaluation 	Pen & paper exercise, question answer session, Process charts, schematic diagrams, illustrations, charts, images	6 hrs.

Annexure 2

Assessment Criteria

CRITERIA FOR ASSESSMENT OF TRAINEES

Job Role: Modeler

Qualification Pack: MES Q 2501

Sector Skill Council: Media and Entertainment Skills Council

Guidelines for Assessment

1. Criteria for assessment for each Qualification Pack will be created by the Sector Skill Council. Each Performance Criteria (PC) will be assigned marks proportional to its importance in NOS. SSC will also lay down proportion of marks for Theory and Skills Practical for each PC.
2. The assessment for the theory part will be based on knowledge bank of questions created by the SSC.
3. Assessment will be conducted for all compulsory NOS, and where applicable, on the selected elective/option NOS/set of NOS.
4. Individual assessment agencies will create unique question papers for theory part for each candidate at each examination/training center (as per assessment criteria below).
5. Individual assessment agencies will create unique evaluations for skill practical for every student at each examination/training center based on this criterion.
6. To pass the Qualification Pack, every trainee should score a minimum of 70% of aggregate marks to successfully clear the assessment.
7. In case of *unsuccessful completion*, the trainee may seek reassessment on the Qualification Pack.

S. No.	NOS	NOS NAME	Weightage
1	MES / N 2501	Interpret the script/ brief/ storyboard	25%
2	MES / N 2502	Prepare computer generated models	30%
3	MES / N 2503	Test computer generated models	35%
4	MES / N 0104	Maintain workplace health and safety	10%
			100%

Assessment outcomes	Assessment criteria for outcomes	Total marks	Marks Allocation		
			Out of	Theory	Skills Practical
MES/ N 2501 (Interpret the script/ brief/ storyboard)	PC1. Understand the script, brief, storyboard from the Art Director and character designers	100	20	10	60
	PC2.Understand the design brief (Appearance, complexion, dressing, moods, personalities, expressions etc.)		20	10	
	PC3.Understand the requirements (number, types, duplicates etc.)		20	5	
	PC4.Understand the specifications (dimensions, operating parameters etc.		20	5	
	PC5.Understand the technical needs of the project (Television, Film, Gaming, Internet, DVD etc.)		10	5	
	PC6.Be aware and responsible of his/her role in the pre-production, production and post-production process		10	5	
		Total	100	40	60
Assessment outcomes	Assessment criteria for outcomes	Total marks	Marks Allocation		
			Out of	Theory	Skills Practical
MES/ N 2502 (Prepare computer generated models)	PC1. Prepare digital models according to the design brief (appearance, complexion, dressing, moods, personalities, expressions etc.), requirements (number, types, duplicates etc.) and specifications (dimensions, operating parameters etc.)	100	25	10	60
	PC2. Create prototypes/pilots for testing		25	10	
	PC3.Understand the final display medium and adapt / suggest the model for its polycounts, mesh complexity, movement capability etc.		25	10	
	PC4. Ensure that the models will be able to perform properly once animated, are uniform and consistent and are delivered in appropriate formats that can be used by others		25	10	

Assessment outcomes	Assessment criteria for outcomes	Total marks	Marks Allocation		
			Out of	Theory	Skills Practical
		Total	100	40	60
Assessment outcomes	Assessment criteria for outcomes	Total marks	Marks Allocation		
			Out of	Theory	Skills Practical
MES/ N 2503 (Test computer generated models)	PC1.Test the models to ensure that they meet the design specifications and production requirements and function as required	100	25	10	60
	PC2.Work out any problems with the models that emerge during production or construction in collaboration with peers and under supervision of the art director and character designers		25	10	
	PC3.Review models with relevant people		15	10	
	PC4.Respond positively to feedback about the models created, making refinements as needed		25	5	
	PC5. Remain constantly flexible and adaptable to new directions, creative requirements and developments in model making		10	5	
		Total	100	40	60
Assessment outcomes	Assessment criteria for outcomes	Total marks	Marks Allocation		
			Out of	Theory	Skills Practical
	PC1. Understand and comply with the organisation's current health, safety and security policies and procedures.	100	10	5	50
	PC2. Understand the safe working practices pertaining to own occupation.		10	5	
	PC3. Understand the government norms and policies relating to health and safety including emergency procedures for illness, accidents, fires or others which may involve evacuation of the premises.		5	3	
	PC4. Participate in organization health and safety knowledge sessions and drills.		5	2	

Assessment outcomes	Assessment criteria for outcomes	Total marks	Marks Allocation		
			Out of	Theory	Skills Practical
MES/N0104 (Maintain workplace health and safety)	PC5. Identify the people responsible for health and safety in the workplace, including those to contact in case of an emergency.		10	5	
	PC6. Identify security signals e.g. fire alarms and places such as staircases, fire warden stations, first aid and medical rooms.		10	5	
	PC7. Identify aspects of your workplace that could cause potential risk to own and others health and safety.		10	5	
	PC8. Ensure own personal health and safety, and that of others in the workplace through precautionary measures.		10	5	
	PC9. Identify and recommend opportunities for improving health, safety, and security to the designated person.		5	3	
	PC10. Report any hazards outside the individual's authority to the relevant person in line with organisational procedures and warn other people who may be affected.		10	5	
	PC11. Follow organisation's emergency procedures for accidents, fires or any other natural calamity in case of a hazard.		10	5	
	PC12. Identify and correct risks like illness, accidents, fires or any other natural calamity safely and within the limits of individual's authority.		5	2	
	Total	100	50	50	

DO



- Explain each Guideline for Assessment in detail
- Explain the score that each trainee needs to obtain
- Recapitulate each NOS one-by-one and take participants through the allocation of marks for Theory and Skills Practical.

Explain the Allocation of Marks. Explain that they will be assessed on Theory and Skills Practical.

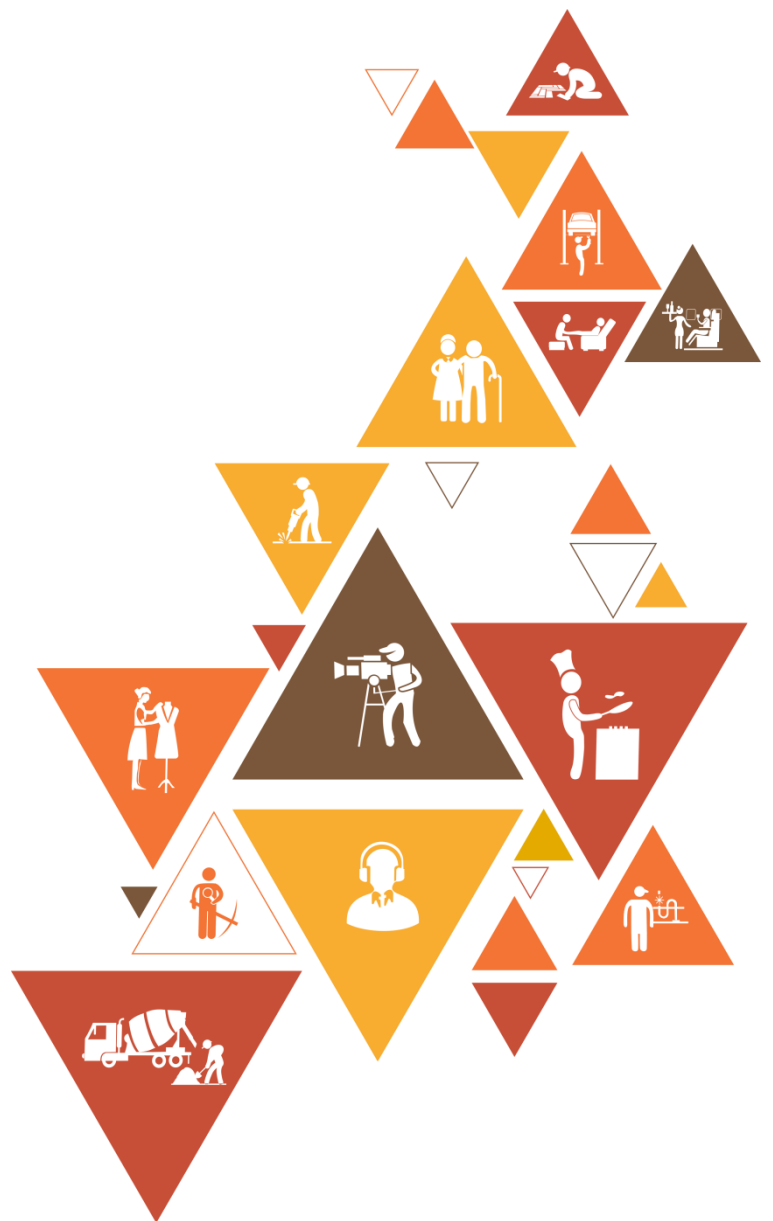



Skill India
कौशल भारत-कुशल भारत



सत्यमेव जयते
GOVERNMENT OF INDIA
MINISTRY OF SKILL DEVELOPMENT
& ENTREPRENEURSHIP



N·S·D·C
National
Skill
Development
Corporation

Transforming the skill landscape



Media & Entertainment Skills Council

Address: Media & Entertainment Skills Council
522-524, 5th Floor,
DLF Tower A, Jasola New Delhi-110025

Email: info@mescindia.com

Web: www.mescindia.org

Phone: +911149048335/49048336

CIN No.: 00000000